



Switching Regulator – SiS2576-ADJ

3A Step-Down Adjustable Voltage Regulator in bare die form

Rev 1.0
30/09/21

Description

The SiS2576-ADJ is a monolithic step-down(buck) switching regulator provisioned to drive 3A loads with very tight line and load regulation. The device is internally equipped with frequency compensation and fixed frequency oscillator. The device delivers higher efficiency than the traditional 3-terminal linear regulator and enables reduction or in some cases elimination of heat sinking. The SiS2576 operates with a minimal number of external components and makes use of a widely available and optimized inductor to simplify switch-mode power design. The device features a guaranteed $\pm 4\%$ output voltage (within specified input voltages and output load conditions) and $\pm 10\%$ oscillator frequency tolerance. External shutdown is integrated and features 50 μ A (typical) standby current. The output switch is equipped with cycle-by-cycle current limiting and thermal shutdown for full protection during fault conditions.

Features:

- Adjustable output range
- Guaranteed output current
- Wide 40V input range
- Requires x6 external components only
- 52kHz fixed frequency internal oscillator
- TTL shutdown capability, low power standby mode
- High efficiency
- Uses readily available standard inductors
- Thermal shutdown and current limit protection
- Reduced heat sink requirement versus linear regulators.

Ordering Information

The following part suffixes apply:

- No suffix - MIL-STD-883 /2010B Visual Inspection

For High Reliability versions of this product please see

[SiS1576-ADJ](#)

Supply Formats:

- Default – Die in Waffle Pack (100 per tray capacity)
- Sawn Wafer on Tape – On request
- Unsawn Wafer – On request
- Die Thickness \leftrightarrow 380 μ m(15 Mils) – On request
- Assembled into in TO-220 package – On request

Die Dimensions in μ m (mils)

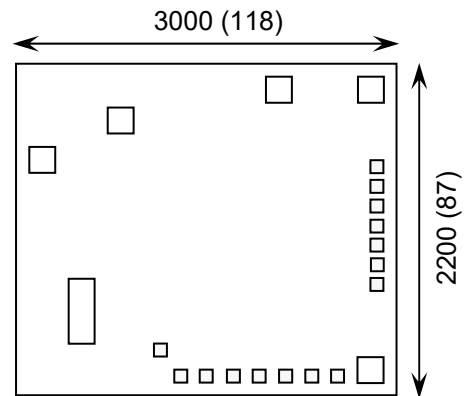

Mechanical Specification

Die Size (Un-sawn)	3000 x 2200 118 x 87	μ m mils
Minimum Bond Pad Size	150 x 150 5.90 x 5.90	μ m mils
Die Thickness	380 (± 20) 14.96 (± 0.79)	μ m mils
Top Metal Composition	Al	
Back Metal Composition	N/A – Bare Si	





Switching Regulator – SiS2576-ADJ

Rev 1.0
30/09/21

Pad Layout and Functions

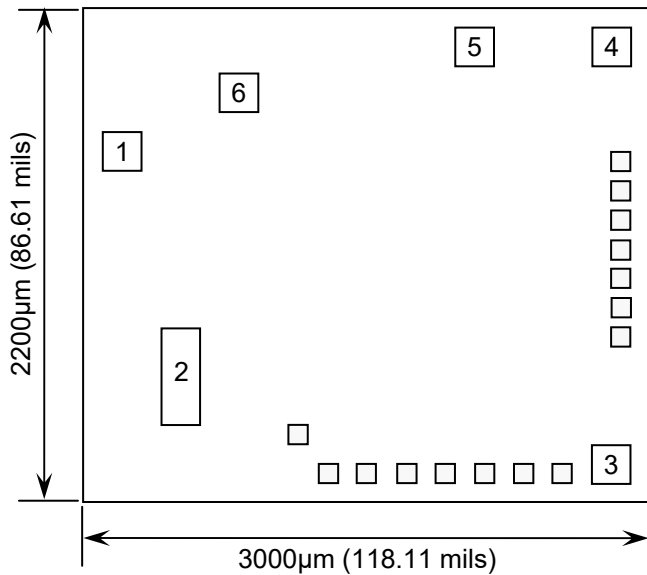

PAD	FUNCTION	COORDINATES (µm)	
		X	Y
1	V _{IN}	83	1439
2	V _{OUT}	827	403
3	FEEDBACK	2767	83
4	ON / OFF	2767	1967
5	GND	2277	1967
6	V _{IN}	1071	1694
GROUND CHIP BACKSIDE			

Pinout (Assembled in TO-220)

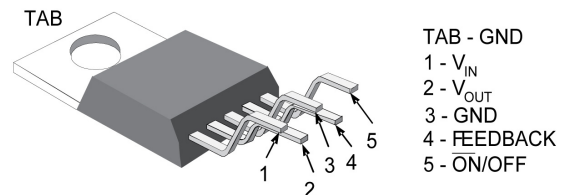

Functional Diagram (Pad assignment)

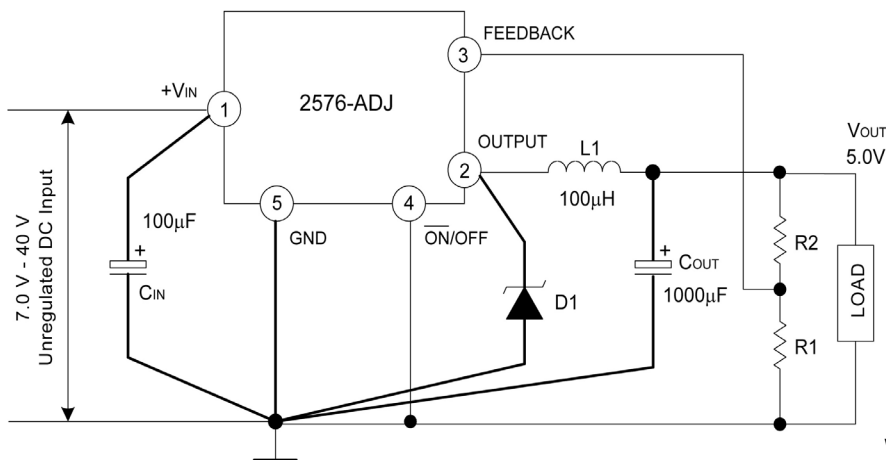

- C_{IN} - 100µF, 75V, Aluminum Electrolytic
- C_{OUT} - 1000µF, 25V, Aluminum Electrolytic
- D1 - Schottky, MBR360
- L1 - 100µH, Pulse Eng. PE-92108
- R1 - 2kΩ, 0.1%
- R2 - 6.12kΩ, 0.1%

$$V_{OUT} = V_{REF} \left(1 + \frac{R2}{R1}\right)$$

$$R2 = R1 \left(\frac{V_{OUT}}{V_{REF}} - 1\right)$$

Where V_{REF} = 1.23V, R1 between 1kΩ & 5kΩ

PAD	FUNCTION	DESCRIPTION
1	V _{IN}	Supply input pin to collector pin of high-side transistor. Connect to power supply and input bypass capacitors C _{IN} . Path from V _{IN} pin to high frequency bypass C _{IN} and GND must be as short as possible.
2	V _{OUT}	Power transistor Emitter pin. This is a switching node. Attach this pin to an inductor & the cathode of the external diode.
3	FEEDBACK	Feedback sense input pin. Connect to the midpoint of feedback divider to set V _{OUT} .
4	ON / OFF	Voltage regulator enable input. High = OFF, Low = ON. Connect to GND to enable. Do not leave this pin floating.
5	GND	Ground pin. Path to C _{IN} must be as short as possible.
CHIP BACK	GND	Attach to heatsink or copper plane for thermal relief where required.





Switching Regulator – SiS2576-ADJ

Rev 1.0
30/09/21

Absolute Maximum Ratings¹ (Voltages referenced to GND unless otherwise stated)

PARAMETER	SYMBOL	VALUE	UNIT
Supply Voltage	V _{CC}	45	V
ON / OFF Pin input Voltage	V _{IN}	-0.3V ≤ V ≤ +V _{IN}	V
Output Voltage to Ground (Steady State)	V _{OUT}	-1	V
Power Dissipation	P _D	Internally Limited	W
Storage Temperature	T _{STG}	-65 to +150	°C
Operating Junction Temperature	T _J	-40 to 125	°C
ESD Rating (C = 100pF, R = 1.5kΩ)	V _{ESD}	≥2	kV

1. Operation above the absolute maximum rating may cause device failure. Operation at the absolute maximum ratings, for extended periods, may reduce device reliability.

Recommended Operating Conditions (Voltages referenced to GND unless otherwise stated)

PARAMETER	SYMBOL	MIN	MAX	UNIT
Operating Temperature	T _J	-40	+125	°C
Supply Voltage	V _{CC}	-	40	V

DC Electrical Characteristics² V_{IN} = 12V, I_{LOAD} = 500mA, T_J = -40°C to +125°C (unless noted otherwise)

PARAMETER	SYMBOL	CONDITIONS	LIMITS			UNITS	
			MIN	TYP	MAX		
Feedback Voltage	V _{OUT}	V _{IN} = 12V, I _{LOAD} = 0.5A, V _{OUT} = 5V, T _J = 25°C	1.217	1.230	1.243	V	
		8.0V ≤ V _{IN} ≤ 40V, 0.5A ≤ I _{LOAD} ≤ 3.0A, V _{OUT} = 5V	T _J = 25°C	1.193	1.230	1.267	V
			Full Range	1.180	-	1.280	
Efficiency	η	V _{IN} = 12V, I _{LOAD} = 3A, V _{OUT} = 5V	-	77	-	%	
Feedback Bias Current	I _b	V _{OUT} = 5V	T _J = 25°C	-	50	100	nA
			Full Range	-	-	500	
Oscillator Frequency ³	f _o	T _J = 25°C		47	52	58	kHz
				42	-	63	
Saturation Voltage ⁴	V _{SAT}	I _{OUT} = 3.0A	T _J = 25°C	-	1.4	1.8	V
			Full Range	-	-	2.0	
Max Duty Cycle (ON) ⁵	DC		93	98	-	%	
Current Limit ^{3,4}	I _{CL}		T _J = 25°C	4.2	5.8	6.9	A
			Full Range	3.5	-	7.5	
Output Leakage ⁶ Current	I _L	Output = 0V, V _{IN} = 40V T _J = 25°C	-	-	2.0	mA	
		Output = -1V, V _{IN} = 40V T _J = 25°C	-	7.5	30		
Quiescent Current ⁶	I _Q	T _J = 25°C	-	5	10	mA	
Standby Current	I _{STBY}	ON/OFF Pin = 5V(off), T _J = 25°C	-	50	200	μA	

2. External components such as the catch diode, inductor, input and output capacitors can affect switching regulator system performance. When the SiS2576-ADJ is used as shown in the Functional diagram with related external components, system performance will be as shown in system parameters section of Electrical Characteristics and associated figures.





Switching Regulator – SiS2576-ADJ

Rev 1.0
30/09/21

DC Electrical Characteristics $V_{IN} = 12V, I_{LOAD} = 500mA, T_J = -40^{\circ}C$ to $+125^{\circ}C$ (unless noted otherwise)

PARAMETER	SYMBOL	CONDITIONS	LIMITS			UNITS	
			MIN	TYP	MAX		
ON / OFF CONTROL							
\overline{ON} / OFF Pin Logic Input Level	V_{IH}	$V_{OUT} = 0V$	$T_J = 25^{\circ}C$	2.2	1.4	-	V
			Full Range	2.4	-	-	
	$T_J = 25^{\circ}C$		-	1.2	1.0		
	Full Range		-	-	0.8		
\overline{ON} / OFF Pin Input Current	I_{IH}	$T_J = 25^{\circ}C$	-	12	30	μA	
	I_{IL}		-	0	10		

3. The oscillator frequency reduces to approximately 11 kHz in the event of an output short or an overload which causes the regulated output voltage to drop approximately 40% from the nominal output voltage. This self protection feature lowers the average dissipation of the IC by lowering the minimum duty cycle from 5% down to approximately 2%. 4. Output (Pad 2) sourcing current. No diode, inductor or capacitor connected to output. 5. Feedback (Pad 3) removed from output and connected to 0V. 6. Feedback (Pad 3) removed from output and connected to +12V, to force the output transistor "OFF"

Typical Performance Characteristics²

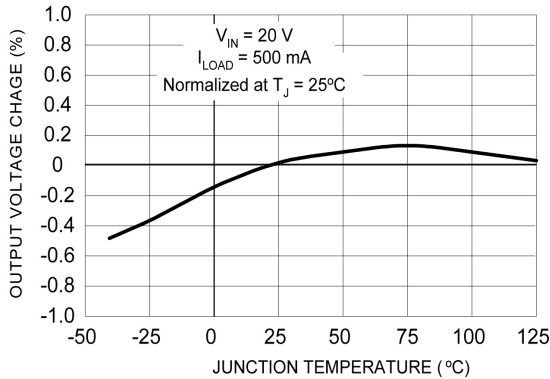

Figure 1 – Normalized output voltage

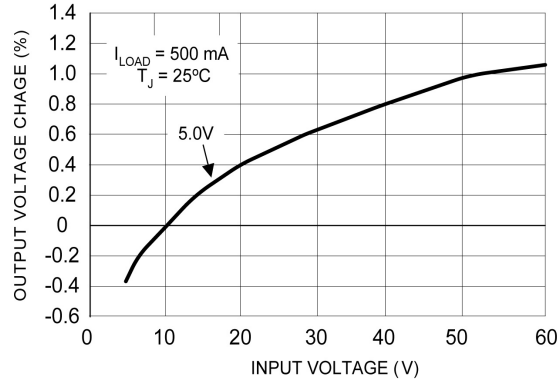

Figure 2 – Line Regulation

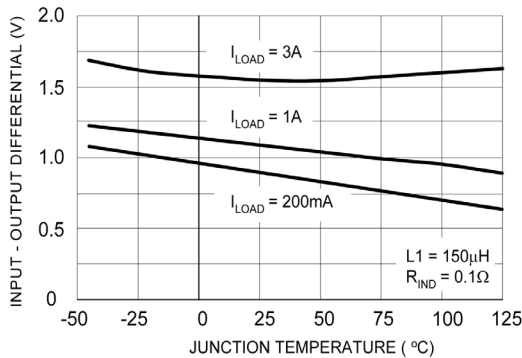

Figure 3 – Dropout Voltage

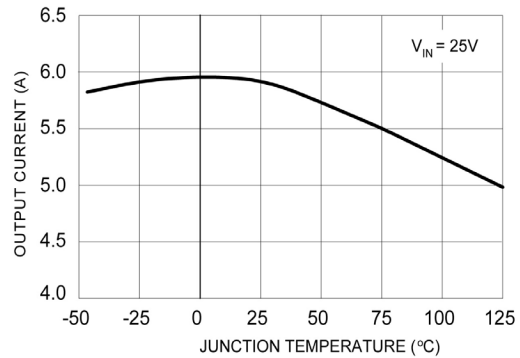

Figure 4 – Current Limit





Switching Regulator – SiS2576-ADJ

Typical Performance Characteristics continued²

Rev 1.0
30/09/21

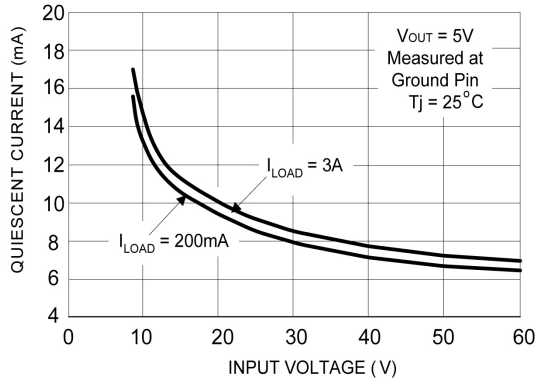

Figure 5 – Quiescent Current

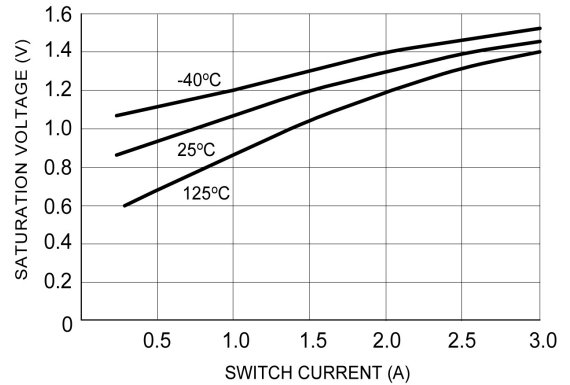

Figure 6 – Switch Saturation Voltage

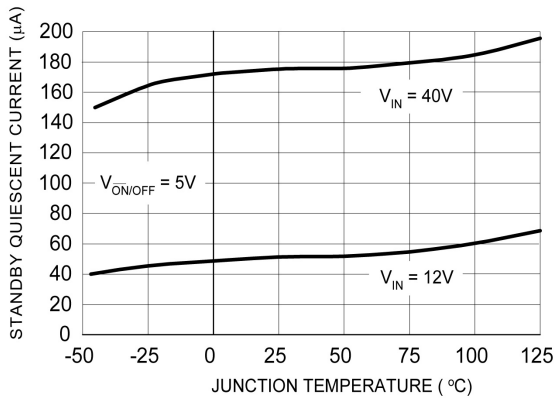

Figure 7 – Standby Quiescent Current

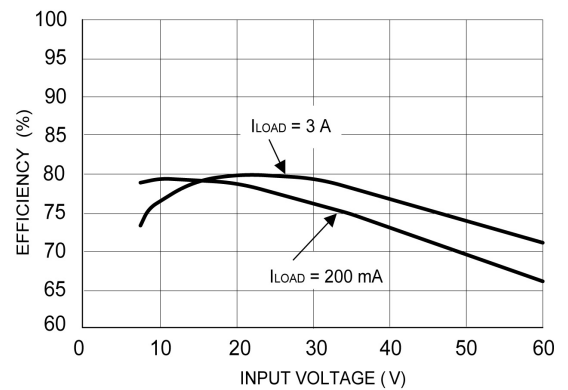

Figure 8 – Efficiency

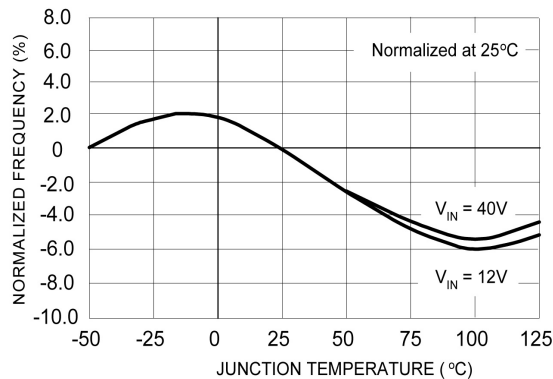

Figure 9 – Oscillator Frequency





Switching Regulator – SiS2576-ADJ

Rev 1.0
30/09/21

Block Diagram

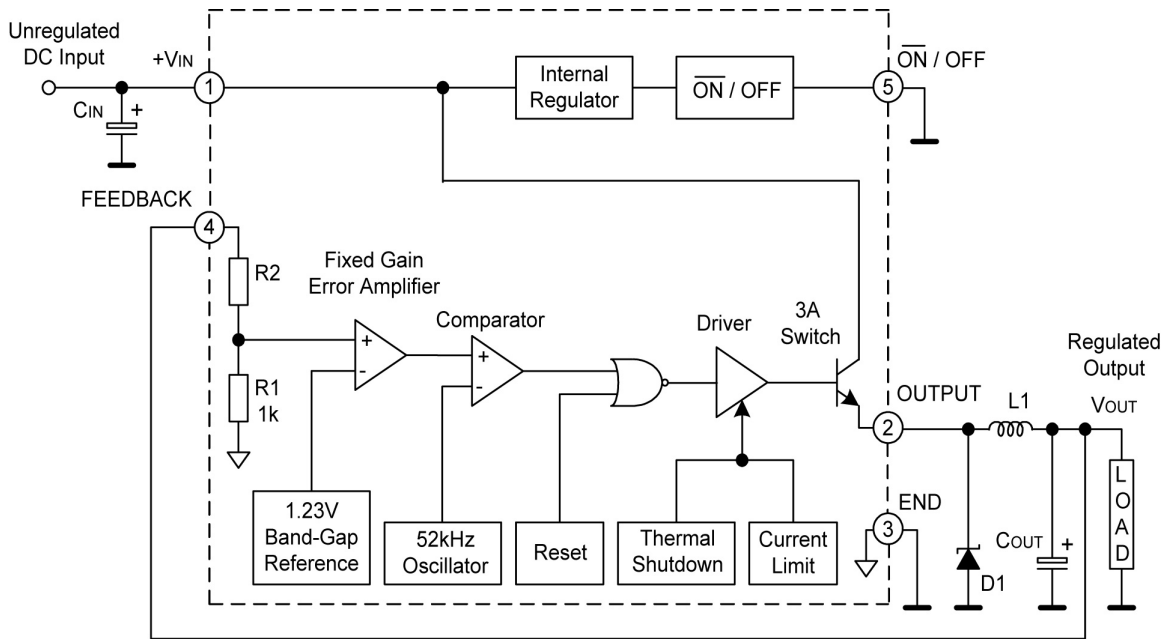

R1 = Open, R2 = 0Ω

DISCLAIMER: The information given in this document shall in no event be regarded as a guarantee of conditions or characteristics. With respect to any examples or hints given herein, any typical values stated herein and/or any information regarding the application of the device, Silicon Supplies Ltd hereby disclaims any and all warranties and liabilities of any kind.

LIFE SUPPORT POLICY: Silicon Supplies Ltd components may be used in life support devices or systems only with the express written approval of Silicon Supplies Ltd, if a failure of such components can reasonably be expected to cause the failure of that life support device or system or to affect the safety or effectiveness of that device or system. Life support devices or systems are intended to be implanted in the human body or to support and/or maintain and sustain and/or protect human life. If they fail, it is reasonable to assume that the health of the user or other persons may be endangered.

