



# Linear Voltage Regulator – LM2940-9

Positive Fixed 9V Voltage Regulator in bare die form

Rev 1.1  
3/11/17

## Description

The LM2940-9 positive voltage regulator features the ability to source 1A of output current with a dropout voltage of typically 0.5V & a maximum of 1V over the entire temperature range. A quiescent current reduction circuit has been included which reduces the ground current when the differential between the input voltage & the output voltage exceeds approximately 3V. The quiescent current with 1A of output current & an input-output differential of 5V is therefore only 30 mA. Higher quiescent currents only exist when the regulator is in the dropout mode ( $V_{IN} - V_{OUT} \leq 3V$ ).

## Features:

- Dropout voltage typically 0.5V @  $I_o = 1A$
- Output current in excess of 1A
- Reverse battery protection
- Internal short circuit current limit
- Full Military Temperature Range.

## Ordering Information

The following part suffixes apply:

- No suffix - MIL-STD-883 /2010B Visual Inspection
- "H" - MIL-STD-883 /2010B Visual Inspection + MIL-PRF-38534 Class H LAT
- "K" - MIL-STD-883 /2010A Visual Inspection (Space) + MIL-PRF-38534 Class K LAT

LAT = Lot Acceptance Test.

For further information on LAT process flows see below.

[www.siliconsupplies.com/quality/bare-die-lot-qualification](http://www.siliconsupplies.com/quality/bare-die-lot-qualification)

## Die Dimensions in $\mu\text{m}$ (mils)

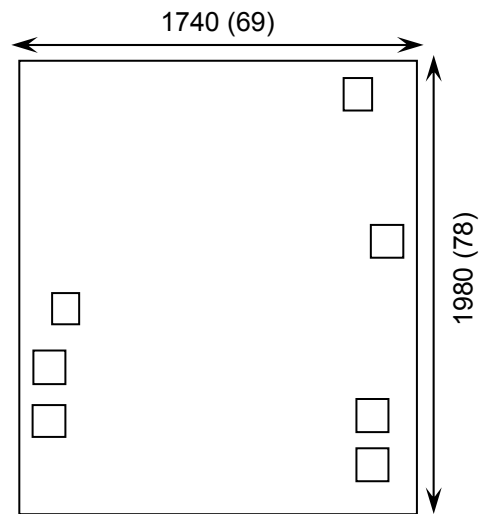

## Supply Formats:

- Default – Die in Waffle Pack (100 per tray capacity)
- Sawn Wafer on Tape – By specific request
- Unsawn Wafer – By specific request
- Tape & Reel – By specific request
- TO-3 hermetic package – By specific request

## Mechanical Specification

Die Size (Unsawn)	1740 x 1980 69 x 78	$\mu\text{m}$ mils
Minimum Bond Pad Size	116 x 134 4.57 x 5.28	$\mu\text{m}$ mils
Die Thickness	280 ( $\pm 10$ ) 11 ( $\pm 0.4$ )	$\mu\text{m}$ mils
Top Metal Composition	Al 1%Si 1.1 $\mu\text{m}$	
Back Metal Composition	Ti/Ni/Ag 3 $\mu\text{m}$	





# Linear Voltage Regulator – LM2940-9

Rev 1.1  
3/11/17

## Pad Layout and Functions

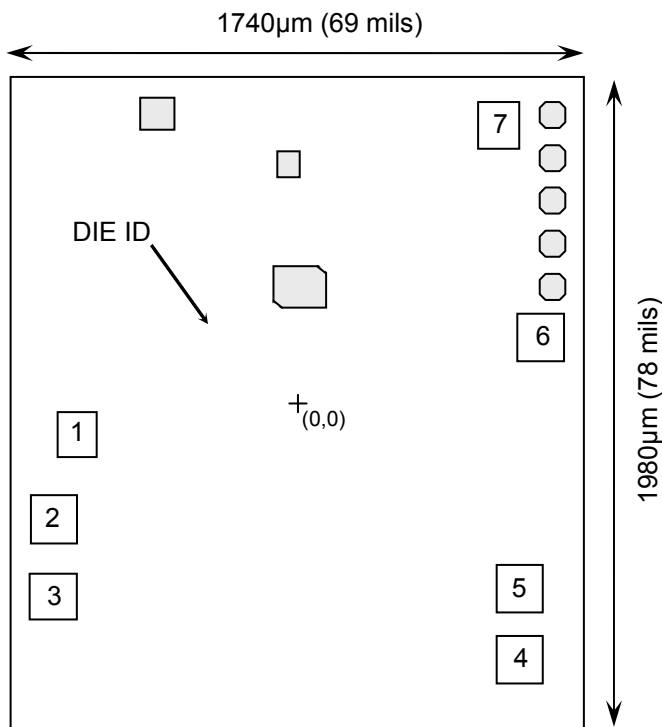

PAD	FUNCTION	COORDINATES (µm)	
		X	Y
1	GND	-667	-94
2	VCC	-738.5	-352
3	VCC	-738.5	-584
4	OUT	675.5	-776
5	OUT	675.5	-559
6	OUT	739.5	201.5
7	GND	775	877
CONNECT CHIP BACK TO GND			

## Typical Application

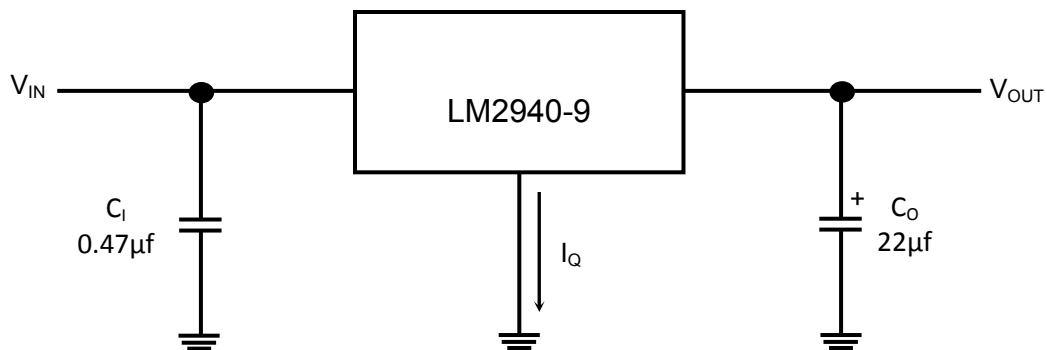



# Linear Voltage Regulator – LM2940-9

Rev 1.1  
3/11/17

## Absolute Maximum Ratings

PARAMETER	SYMBOL	VALUE	UNIT
Input Voltage	$V_{IN}$	26	V
Power Dissipation	$P_D$	Internally Limited	
Operating Temperature Range	-	-55 to 125	°C
Maximum Junction Temperature	$T_J$	150	°C
Storage Temperature	$T_{STG}$	-65 to 150	°C

## DC Electrical Characteristics $T_J = 25^\circ\text{C}$ , $V_{IN} = V_{OUT} + 5\text{V}$ , $I_{OUT} = 1\text{A}$ , $C_O = 22\mu\text{F}$ unless otherwise specified

PARAMETER	SYMBOL	TEST CONDITIONS	MIN	TYP	MAX	UNITS
Output Voltage	$V_{OUT}$	$10.5\text{V} \leq V_{IN} \leq 26\text{V}$ , $5\text{mA} \leq I_{OUT} \leq 1\text{A}$	8.73	9.00	9.27	V
		$T_J = 125^\circ\text{C}$	8.55	-	9.45	
Line Regulation	$\Delta V_{OUT}$	$V_{OUT} + 2\text{V} \leq V_{IN} \leq 26\text{V}$ , $I_{OUT} = 5\text{mA}$	-	20	90	mV
		$T_J = 125^\circ\text{C}$	-	-	-	
Load Regulation	$\Delta V_{OUT}$	$50\text{mA} \leq I_{OUT} \leq 1\text{A}$	-	60	90	mV
		$T_J = 125^\circ\text{C}$	-	-	150	
Output Impedance	$R_{OUT}$	100mA DC and 20mA <sub>RMS</sub> , $f_O = 120\text{Hz}$	-	60	-	mΩ
		$T_J = 125^\circ\text{C}$	-	-	1000	
Quiescent Current	$I_Q$	$V_{OUT} + 2\text{V} \leq V_{IN} \leq 26\text{V}$ , $I_{OUT} = 5\text{mA}$	-	10	15	mA
		$T_J = 125^\circ\text{C}$	-	-	20	
		$V_{IN} = V_{OUT} + 5\text{V}$ , $I_{OUT} = 1\text{A}$	-	30	45	mA
		$T_J = 125^\circ\text{C}$	-	-	60	
Output Noise Voltage	$e_N$	10Hz-100KHz, $I_{OUT} = 5\text{mA}$	-	270	-	$\mu\text{V}_{RMS}$
		$T_A = 125^\circ\text{C}$	-	-	1000	
Ripple Rejection	RR	$f_O = 120\text{Hz}$ , 1V <sub>RMS</sub> , $I_{OUT} = 100\text{mA}$	52	64	-	dB
		$T_J = 125^\circ\text{C}$	-	-	-	
Long Term Stability			-	34	-	mV/1000hr
Dropout Voltage	$V_D$	$I_{OUT} = 1\text{A}$	-	0.5	0.8	V
		$T_J = 125^\circ\text{C}$	-	-	1.0	
		$I_{OUT} = 100\text{mA}$	-	0.13	0.15	
		$T_J = 125^\circ\text{C}$	-	-	0.20	
Short Circuit Current	$I_{SC}$	Note 1	-	2.5	-	A
Maximum Line Transient	$T_{IN}$	$R_{OUT} = 100\Omega$ , $T \leq 100\text{ms}$	60	75	-	V
		$T_J = 125^\circ\text{C}$ , $R_{OUT} = 100\Omega$ , $T \leq 20\text{ms}$	60	-	-	
Reverse Polarity DC Input Voltage	$V_{RIN}$	$R_{OUT} = 100\Omega$ , $T_J = 25^\circ\text{C}$ to $125^\circ\text{C}$	-15	-30	-	V
Reverse Polarity Transient Input Voltage	$V_{TRRI}$	$R_{OUT} = 100\Omega$ , $T \leq 100\text{ms}$	-50	-75	-	V
		$T_J = 125^\circ\text{C}$	-50	-	-	

Notes: 1. Output current will decrease with temperature increase but will not drop below 1A at the maximum specified temperature.





# Linear Voltage Regulator – LM2940-9

Rev 1.1  
3/11/17

## Typical Performance Characteristics

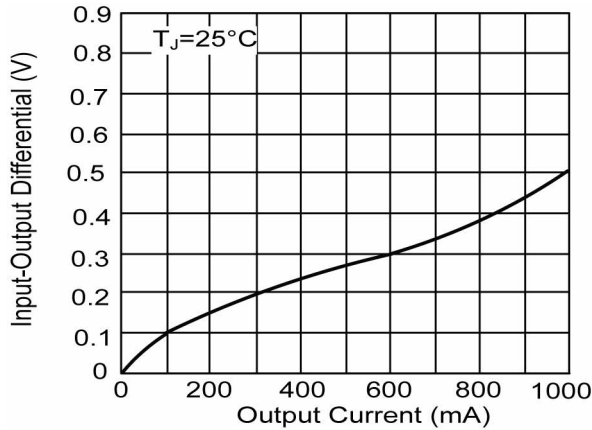

FIGURE 1. Dropout Voltage versus Output Current

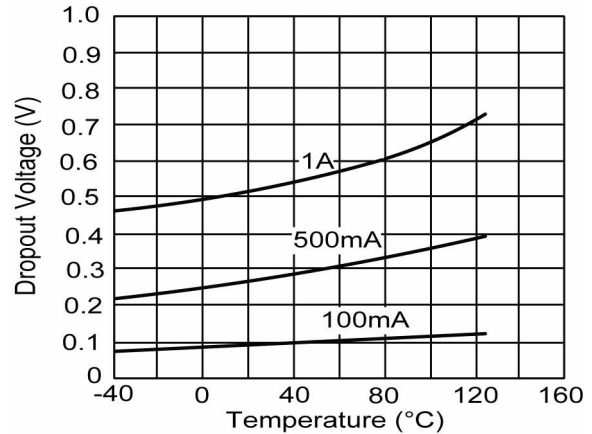

FIGURE 2. Dropout Voltage versus Temperature

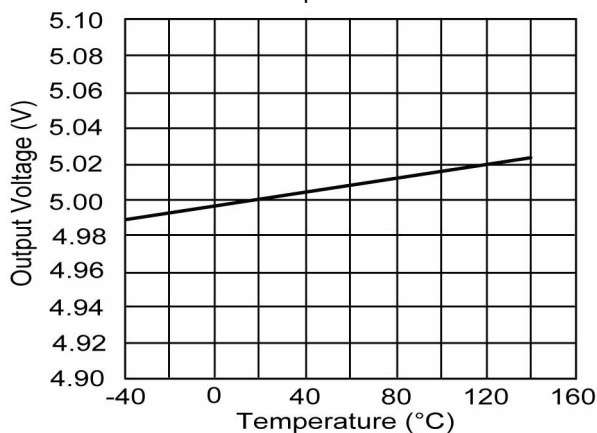

FIGURE 3. Output Voltage versus Temperature

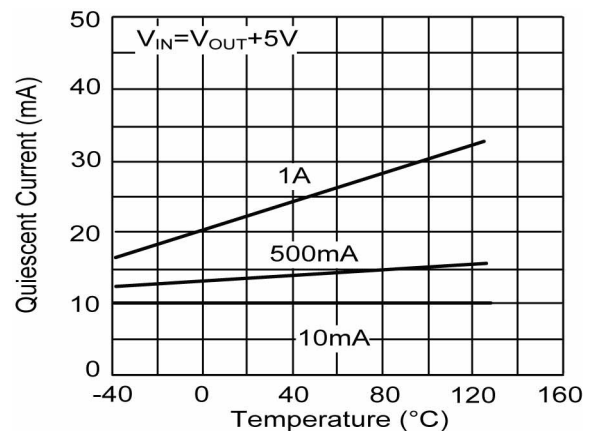

FIGURE 4. Quiescent Current versus Temperature

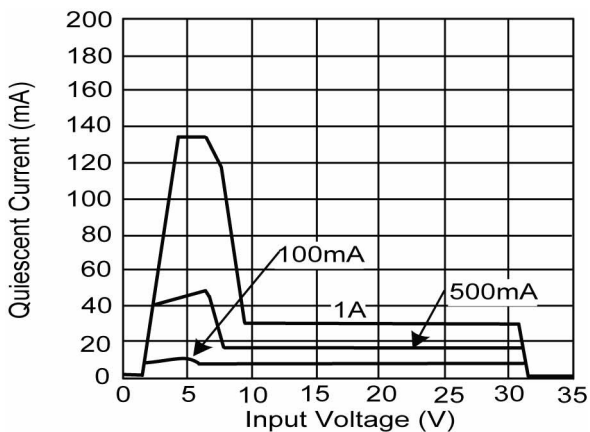

FIGURE 5. Quiescent Current versus Input Voltage

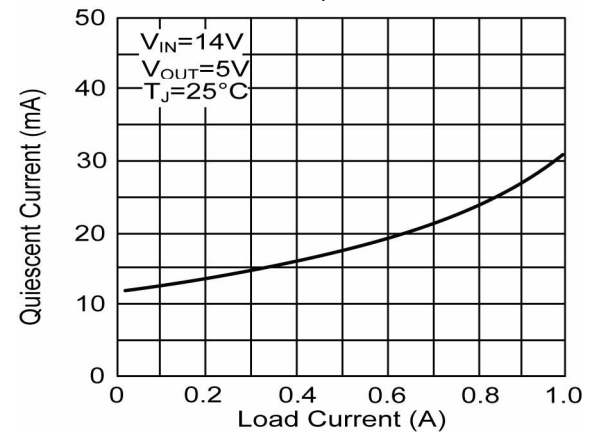

FIGURE 6. Quiescent Current versus Load Current





# Linear Voltage Regulator – LM2940-9

Rev 1.1  
3/11/17

## Typical Performance Characteristics (Continued)

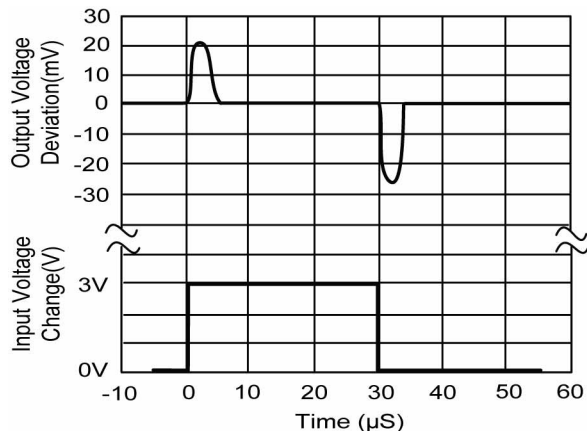

FIGURE 7. Line Transient Response

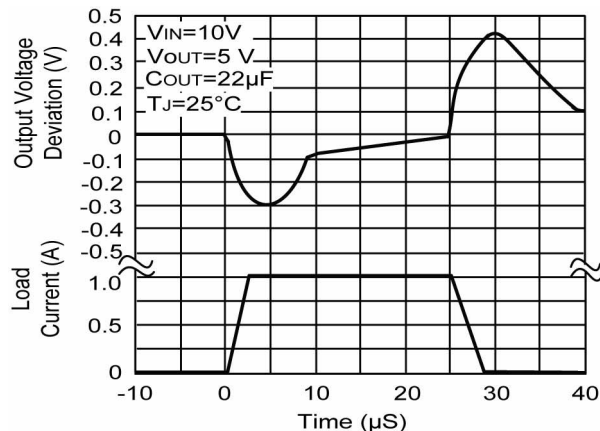

FIGURE 8. Load Transient Response

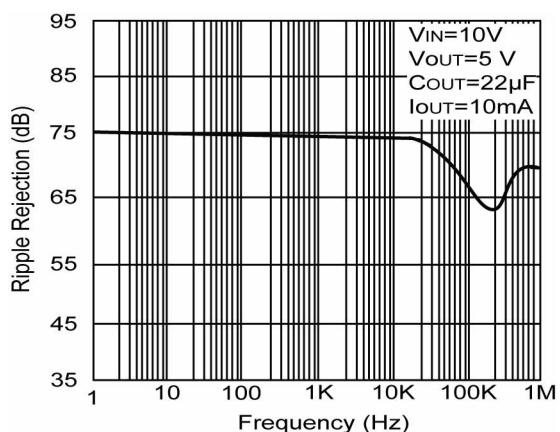

FIGURE 9. Ripple Rejection versus Frequency

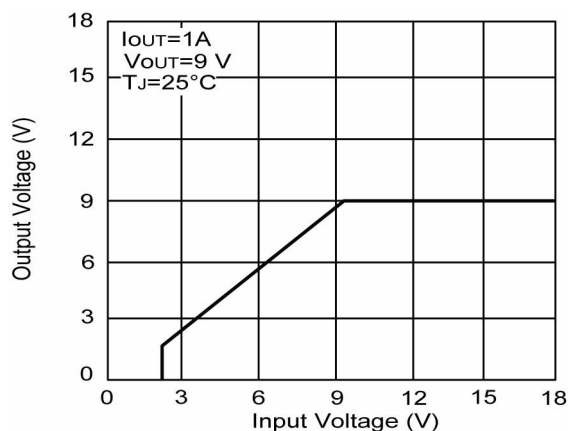

FIGURE 10. Low Voltage Behaviour

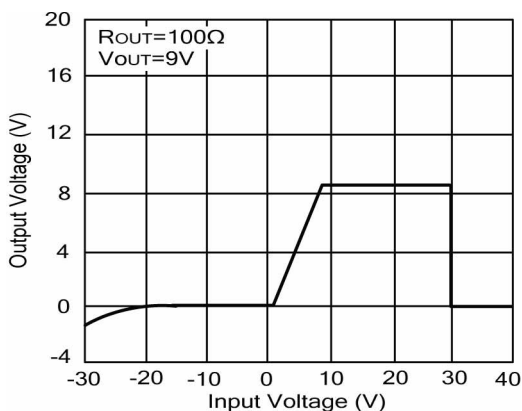

FIGURE 11. Output at Voltage extreme

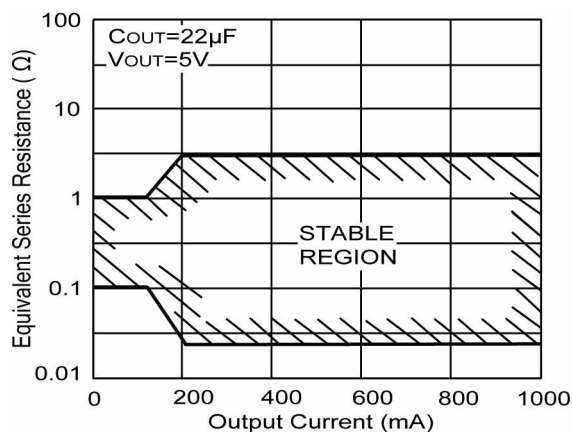

FIGURE 12. Output Capacitor ESR





# Linear Voltage Regulator – LM2940-9

Rev 1.1  
3/11/17

## Typical Performance Characteristics (Continued)

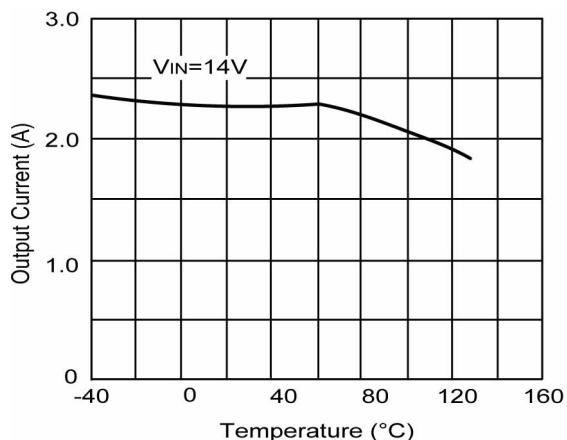

FIGURE 21. Peak Output Current

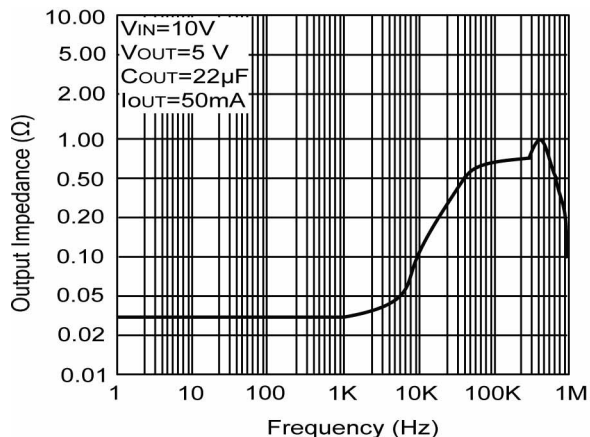

FIGURE 22. Output Impedance

**DISCLAIMER:** The information given in this document shall in no event be regarded as a guarantee of conditions or characteristics. With respect to any examples or hints given herein, any typical values stated herein and/or any information regarding the application of the device, Silicon Supplies Ltd hereby disclaims any and all warranties and liabilities of any kind.

**LIFE SUPPORT POLICY:** Silicon Supplies Ltd components may be used in life support devices or systems only with the express written approval of Silicon Supplies Ltd, if a failure of such components can reasonably be expected to cause the failure of that life support device or system or to affect the safety or effectiveness of that device or system. Life support devices or systems are intended to be implanted in the human body or to support and/or maintain and sustain and/or protect human life. If they fail, it is reasonable to assume that the health of the user or other persons may be endangered.

