



Linear Voltage Regulator – LM2940-10

Positive Fixed 9V Voltage Regulator in bare die form

Rev 1.1
3/11/17

Description

The LM2940-10 positive voltage regulator features the ability to source 1A of output current with a dropout voltage of typically 0.5V & a maximum of 1V over the entire temperature range. A quiescent current reduction circuit has been included which reduces the ground current when the differential between the input voltage & the output voltage exceeds approximately 3V. The quiescent current with 1A of output current & an input-output differential of 5V is therefore only 30 mA. Higher quiescent currents only exist when the regulator is in the dropout mode ($V_{IN} - V_{OUT} \leq 3V$).

Features:

- Dropout voltage typically 0.5V @ $I_o = 1A$
- Output current in excess of 1A
- Reverse battery protection
- Internal short circuit current limit
- Full Military Temperature Range.

Ordering Information

The following part suffixes apply:

- No suffix - MIL-STD-883 /2010B Visual Inspection
- "H" - MIL-PRF-883 /2010B Visual Inspection
+ MIL-STD-38534 Class H LAT
- "K" - MIL-PRF-883 /2010A Visual Inspection (Space)
+ MIL-STD-38534 Class K LAT

LAT = Lot Acceptance Test.

For further information on LAT process flows see below.

www.siliconsupplies.com/quality/bare-die-lot-qualification

Die Dimensions in μm (mils)

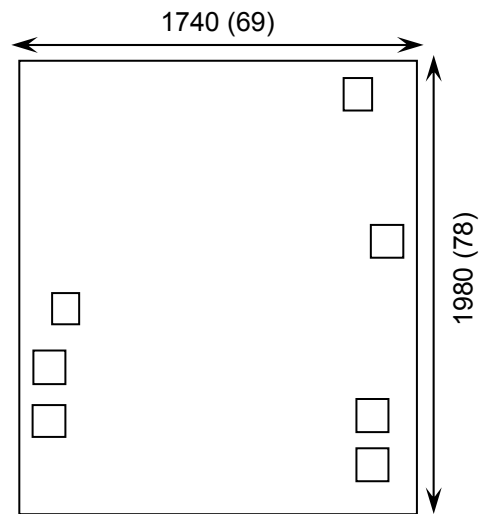

Supply Formats:

- Default – Die in Waffle Pack (100 per tray capacity)
- Sawn Wafer on Tape – By specific request
- Unsawn Wafer – By specific request
- Tape & Reel – By specific request
- TO-3 hermetic package – By specific request

Mechanical Specification

Die Size (Unsawn)	1740 x 1980 69 x 78	μm mils
Minimum Bond Pad Size	116 x 134 4.57 x 5.28	μm mils
Die Thickness	280 (± 10) 11 (± 0.4)	μm mils
Top Metal Composition	Al 1%Si 1.1 μm	
Back Metal Composition	Ti/Ni/Ag 3 μm	





Linear Voltage Regulator – LM2940-10

Rev 1.1
3/11/17

Pad Layout and Functions

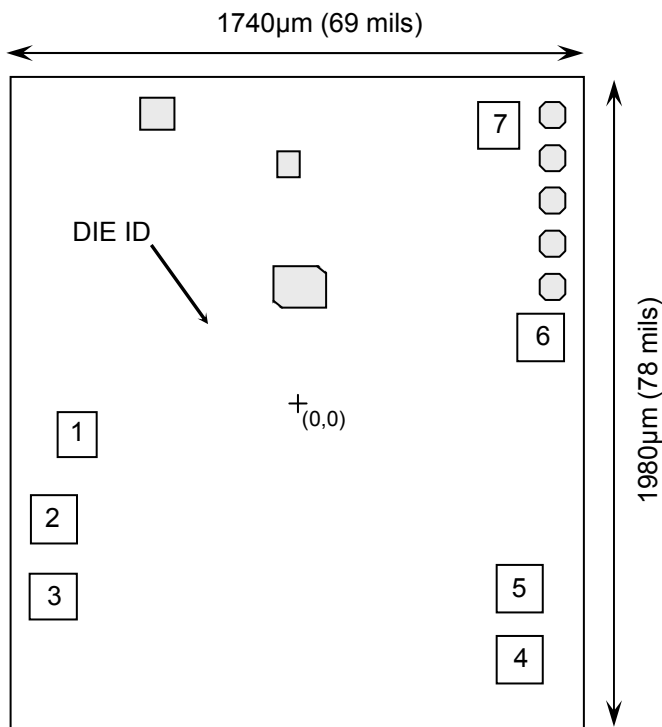

PAD	FUNCTION	COORDINATES (µm)	
		X	Y
1	GND	-667	-94
2	VCC	-738.5	-352
3	VCC	-738.5	-584
4	OUT	675.5	-776
5	OUT	675.5	-559
6	OUT	739.5	201.5
7	GND	775	877
CONNECT CHIP BACK TO GND			

Typical Application

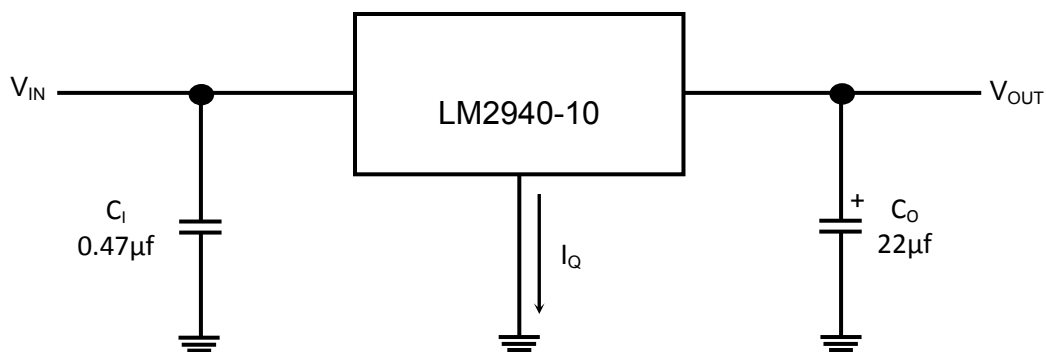



Linear Voltage Regulator – LM2940-10

Rev 1.1
3/11/17

Absolute Maximum Ratings

PARAMETER	SYMBOL	VALUE	UNIT
Input Voltage	V_{IN}	26	V
Power Dissipation	P_D	Internally Limited	
Operating Temperature Range	-	-55 to 125	°C
Maximum Junction Temperature	T_J	150	°C
Storage Temperature	T_{STG}	-65 to 150	°C

DC Electrical Characteristics $T_J = 25^\circ\text{C}$, $V_{IN} = V_{OUT} + 5\text{V}$, $I_{OUT} = 1\text{A}$, $C_O = 22\mu\text{F}$ unless otherwise specified

PARAMETER	SYMBOL	TEST CONDITIONS	MIN	TYP	MAX	UNITS
Output Voltage	V_{OUT}	$11.5\text{V} \leq V_{IN} \leq 26\text{V}$, $5\text{mA} \leq I_{OUT} \leq 1\text{A}$	9.70	10	10.30	V
Line Regulation	ΔV_{OUT}	$V_{OUT} + 2\text{V} \leq V_{IN} \leq 26\text{V}$, $I_{OUT} = 5\text{mA}$	-	20	100	mV
		$T_J = 125^\circ\text{C}$	-	-	-	
Load Regulation	ΔV_{OUT}	$50\text{mA} \leq I_{OUT} \leq 1\text{A}$	-	65	100	mV
		$T_J = 125^\circ\text{C}$	-	-	165	
Output Impedance	R_{OUT}	100mA DC and 20mA _{RMS} , $f_O = 120\text{Hz}$	-	65	-	mΩ
		$T_J = 125^\circ\text{C}$	-	-	1000	
Quiescent Current	I_Q	$V_{OUT} + 2\text{V} \leq V_{IN} \leq 26\text{V}$, $I_{OUT} = 5\text{mA}$	-	10	15	mA
		$T_J = 125^\circ\text{C}$	-	-	20	
		$V_{IN} = V_{OUT} + 5\text{V}$, $I_{OUT} = 1\text{A}$	-	30	45	mA
		$T_J = 125^\circ\text{C}$	-	-	60	
Output Noise Voltage	e_N	10Hz-100KHz, $I_{OUT} = 5\text{mA}$	-	300	-	μV_{RMS}
		$T_A = 125^\circ\text{C}$	-	-	1000	
Ripple Rejection	RR	$f_O = 120\text{Hz}$, 1V_{RMS} , $I_{OUT} = 100\text{mA}$	51	63	-	dB
		$T_J = 125^\circ\text{C}$	45	-	-	
Long Term Stability			-	36	-	mV/1000hr
Dropout Voltage	V_D	$I_{OUT} = 1\text{A}$	-	0.5	0.8	V
		$T_J = 125^\circ\text{C}$	-	-	1.0	
		$I_{OUT} = 100\text{mA}$	-	0.13	0.15	
		$T_J = 125^\circ\text{C}$	-	-	0.20	
Short Circuit Current	I_{SC}	Note 1	-	2.5	-	A
Maximum Line Transient	T_{IN}	$R_{OUT} = 100\Omega$, $T \leq 100\text{ms}$	60	75	-	V
		$T_J = 125^\circ\text{C}$	60	-	-	
Reverse Polarity DC Input Voltage	V_{RIN}	$R_{OUT} = 100\Omega$	-15	-30	-	V
		$T_J = 125^\circ\text{C}$	-15	-	-	
Reverse Polarity Transient Input Voltage	V_{TRRI}	$R_{OUT} = 100\Omega$, $T \leq 100\text{ms}$	-50	-75	-	V
		$T_J = 125^\circ\text{C}$	-50	-	-	

Notes: 1. Output current will decrease with temperature increase but will not drop below 1A at the maximum specified temperature.





Linear Voltage Regulator – LM2940-10

Rev 1.1
3/11/17

Typical Performance Characteristics

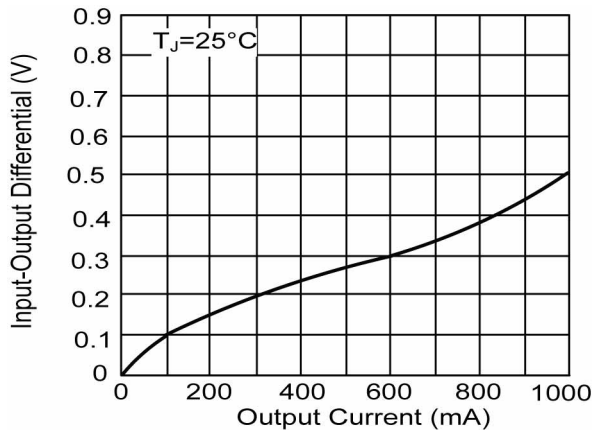

FIGURE 1. Dropout Voltage versus Output Current

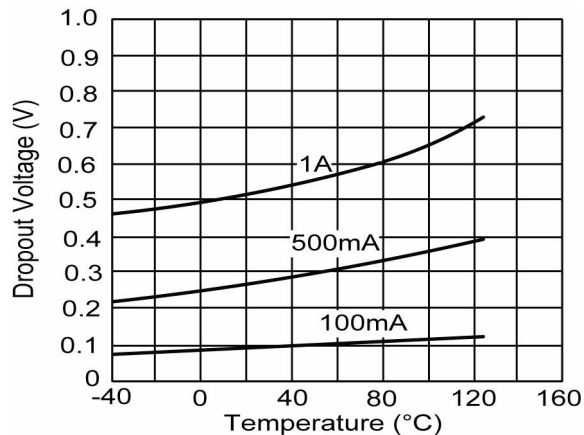

FIGURE 2. Dropout Voltage versus Temperature

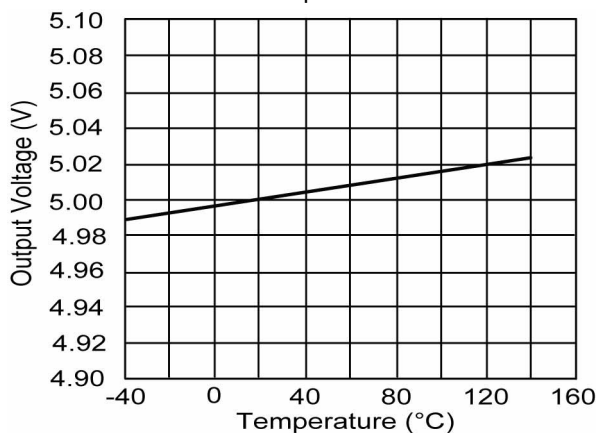

FIGURE 3. Output Voltage versus Temperature

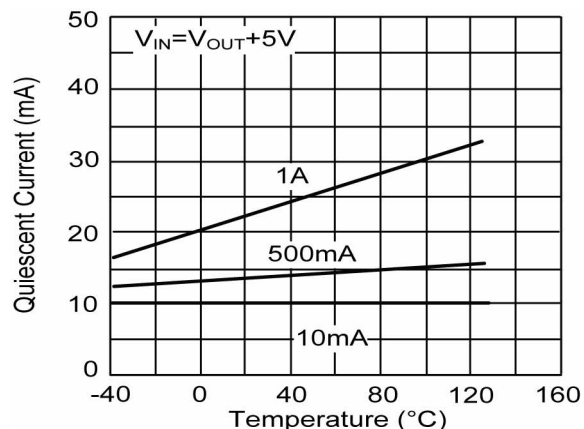

FIGURE 4. Quiescent Current versus Temperature

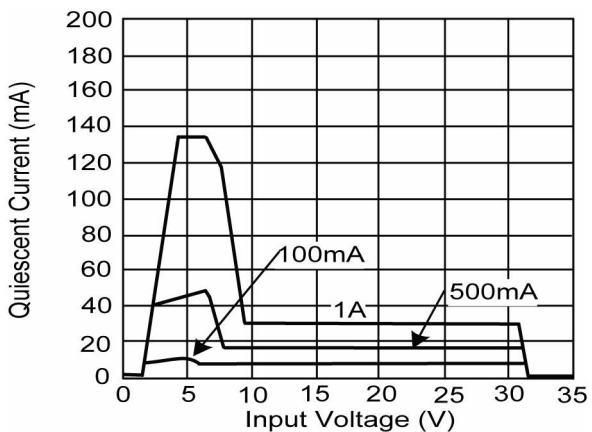

FIGURE 5. Quiescent Current versus Input Voltage

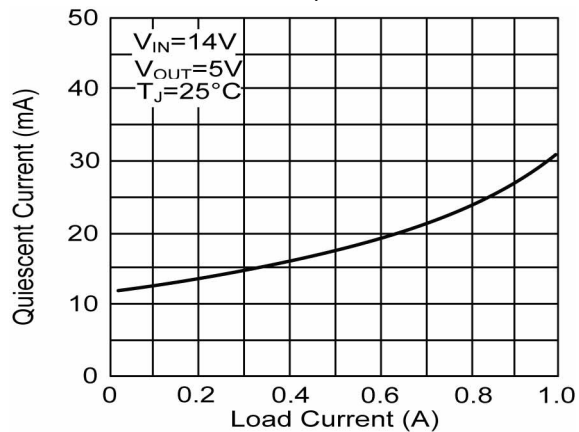

FIGURE 6. Quiescent Current versus Load Current





Linear Voltage Regulator – LM2940-10

Rev 1.1
3/11/17

Typical Performance Characteristics (Continued)

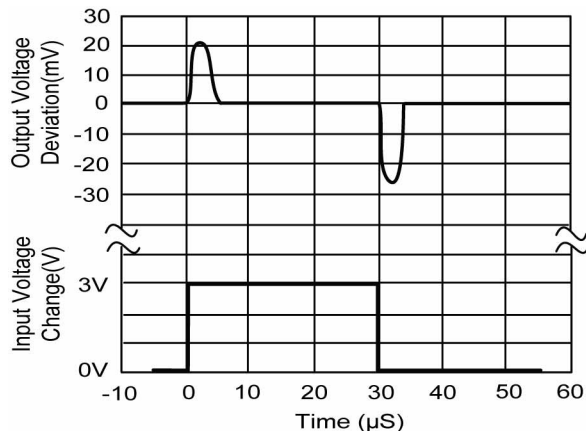

FIGURE 7. Line Transient Response

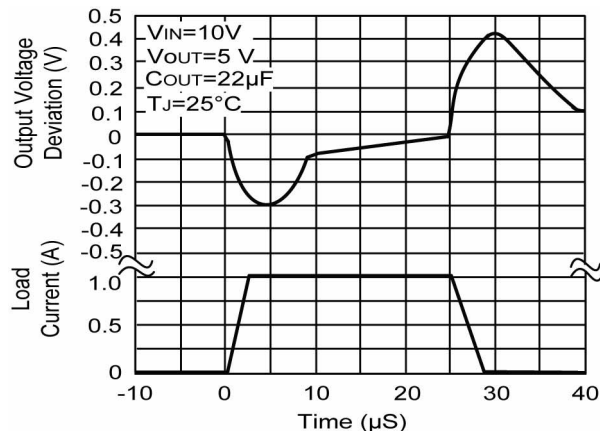

FIGURE 8. Load Transient Response

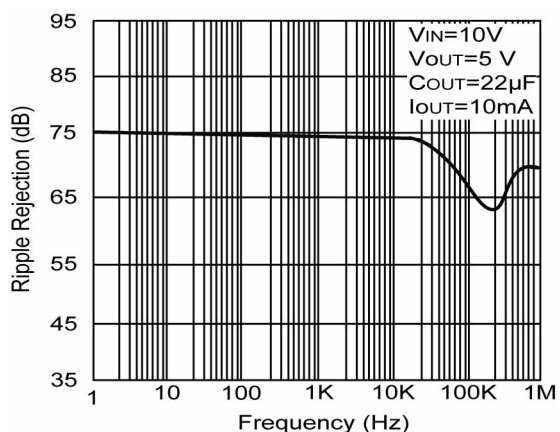

FIGURE 9. Ripple Rejection versus Frequency

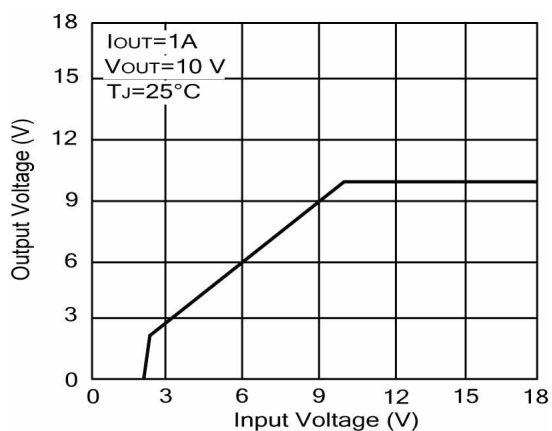

FIGURE 10. Low Voltage Behaviour

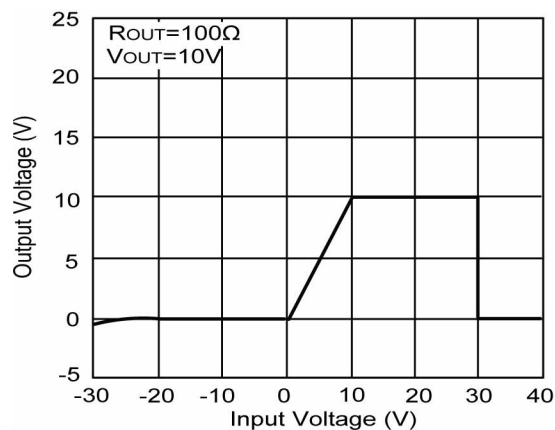

FIGURE 11. Output at Voltage extreme

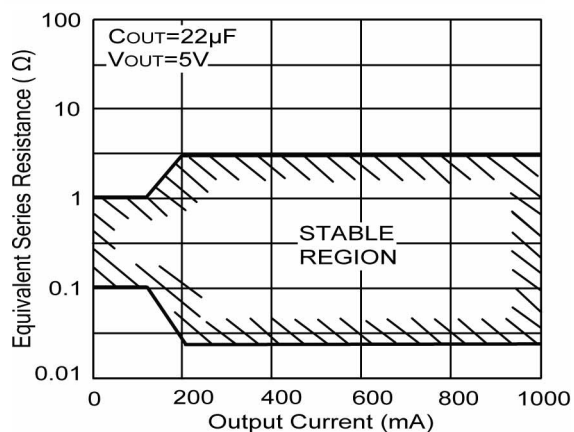

FIGURE 12. Output Capacitor ESR





Linear Voltage Regulator – LM2940-10

Rev 1.1
3/11/17

Typical Performance Characteristics (Continued)

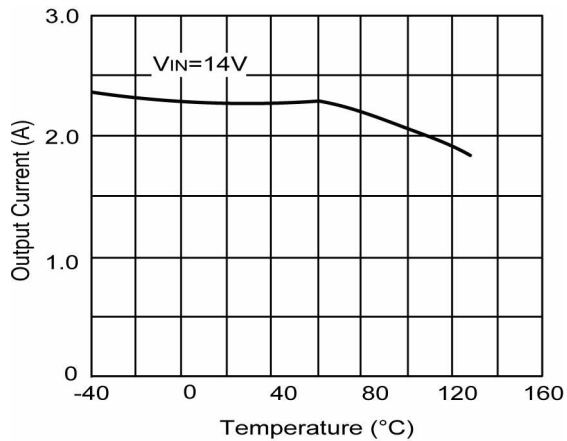

FIGURE 21. Peak Output Current

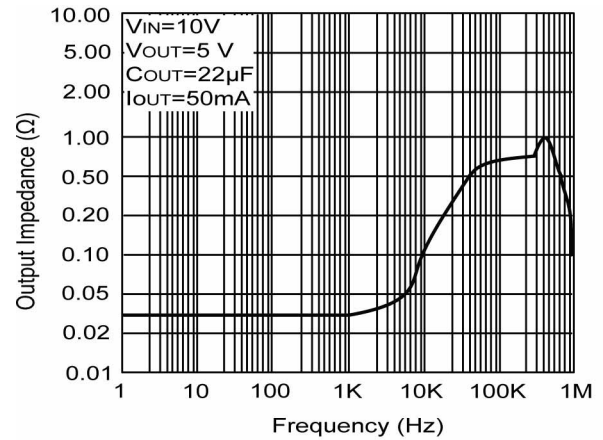

FIGURE 22. Output Impedance

DISCLAIMER: The information given in this document shall in no event be regarded as a guarantee of conditions or characteristics. With respect to any examples or hints given herein, any typical values stated herein and/or any information regarding the application of the device, Silicon Supplies Ltd hereby disclaims any and all warranties and liabilities of any kind.

LIFE SUPPORT POLICY: Silicon Supplies Ltd components may be used in life support devices or systems only with the express written approval of Silicon Supplies Ltd, if a failure of such components can reasonably be expected to cause the failure of that life support device or system or to affect the safety or effectiveness of that device or system. Life support devices or systems are intended to be implanted in the human body or to support and/or maintain and sustain and/or protect human life. If they fail, it is reasonable to assume that the health of the user or other persons may be endangered.

