



High Speed CMOS Logic – 74HC4060

14-Stage Binary Ripple Counter / Divider with Oscillator in bare die form

Rev 1.0
26/11/17

Description

The 74HC4060 is produced on a 2.5µm 5V CMOS process with high speed LSTTL performance combined with CMOS low power consumption. The device consists of 14 master–slave flip–flops & an oscillator with frequency controlled either by crystal or by external RC circuit. Each flip–flop output feeds the next where each output frequency is half the preceding one. A high-to-low transition on the clock input increments the counter. The active–high Reset is asynchronous & disables the oscillator for low standby power consumption. Ten kinds of divided output are provided; 4 to 10 & 12 to 14 stage inclusive. Maximum division available at Q12 is 1/16384 of oscillator frequency.

Features:

- Output Drive Capability: 10 LSTTL Loads
- Low Input Current: 1µA
- Outputs directly interface CMOS, NMOS and TTL
- Operating Voltage Range: 2V to 6V
- CMOS High Noise Immunity
- Function compatible with CD4060B.

Ordering Information

The following part suffixes apply:

- No suffix - MIL-STD-883 /2010B Visual Inspection

For High Reliability versions of this product please see

[54HC4060](#)

Die Dimensions in µm (mils)

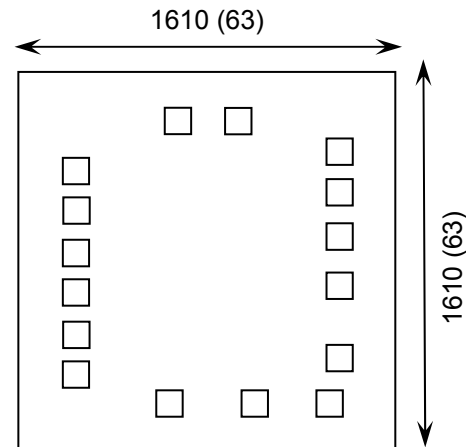

Supply Formats:

- Default – Die in Waffle Pack (100 per tray capacity)
- Sawn Wafer on Tape – On request
- Unsawn Wafer – On request
- Die Thickness <=> 350µm(14 Mils) – On request
- Assembled into Ceramic Package – On request

Mechanical Specification

Die Size (Unsawn)	1610 x 1610 63 x 63	µm mils
Minimum Bond Pad Size	110 x 110 4 x 4	µm mils
Die Thickness	350 (±20) 13.78 (±0.79)	µm mils
Top Metal Composition	Al 1%Si 1.1µm	
Back Metal Composition	N/A – Bare Si	





High Speed CMOS Logic – 74HC4060

Rev 1.0
26/11/17

Pad Layout and Functions

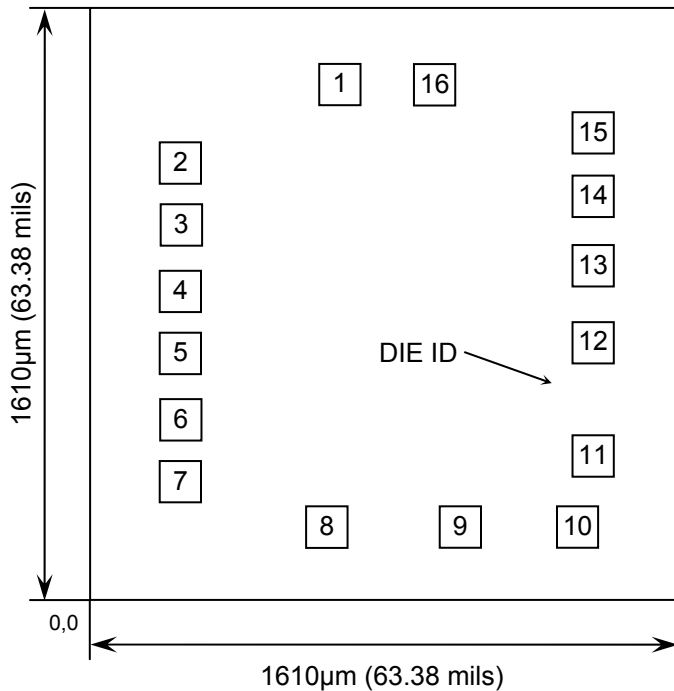

PAD	FUNCTION	COORDINATES (mm)	
		X	Y
1	Q12	0.610	1.350
2	Q13	0.190	1.140
3	Q14	0.190	0.970
4	Q6	0.190	0.790
5	Q5	0.190	0.620
6	Q7	0.190	0.440
7	Q4	0.190	0.270
8	GND	0.590	0.150
9	O _{SC} OUT2	0.950	0.150
10	O _{SC} OUT1	1.270	0.150
11	O _{SC} IN	1.310	0.340
12	MR	1.310	0.650
13	Q9	1.310	0.860
14	Q8	1.310	1.050
15	Q10	1.310	1.220
16	V _{CC}	0.880	1.350

CONNECT CHIP BACK TO V_{CC} OR FLOAT

Logic Diagram

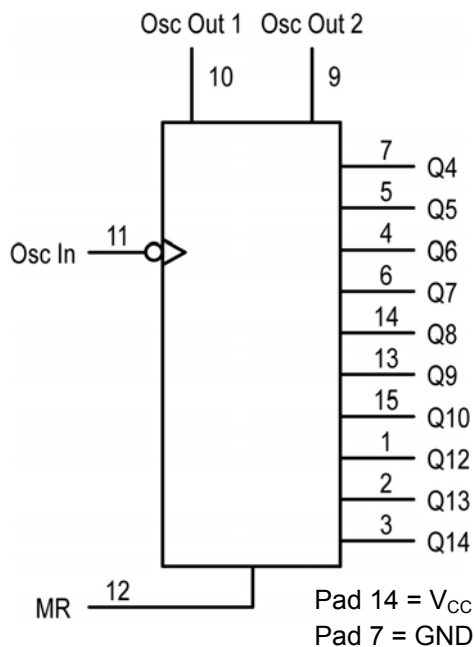

Function Table

CLOCK	RESET	OUTPUT STAGE
	L	NO CHANGE
	L	ADVANCE TO NEXT STATE
X	H	ALL OUTPUTS ARE LOW





High Speed CMOS Logic – 74HC4060

Rev 1.0

26/11/17

Pad Descriptions

INPUTS

Osc IN (Pad 11)

Negative-edge triggering clock input. A high-to-low transition on this input advances the state of the counter. Osc IN may be driven by an external clock source.

CONTROL INPUTS

MR (Pad 12)

Active-high reset. A high level applied to this input asynchronously resets the counter to its zero state (forcing all Q outputs low) and disables the oscillator.

OUTPUTS

Q4—Q10, Q12—Q14 (Pads 7, 5, 4, 6, 13, 15, 1, 2, 3) Active-high outputs. Each Qn output divides the Clock input frequency by 2^N. The user should note the Q1, Q2, Q3 and Q11 are not available as outputs.

Osc OUT1, Osc OUT2 (Pads 9, 10)

Oscillator outputs. These pads are used in conjunction with Osc IN and the external components to form an oscillator. When Osc IN is being driven with an external clock source, Osc OUT1 and Osc OUT2 must be left open circuited. With the crystal oscillator in RC configuration, Osc OUT2 must be left open circuited.

Absolute Maximum Ratings¹

PARAMETER	SYMBOL	VALUE	UNIT
DC Supply Voltage (Referenced to GND)	V _{CC}	-0.5 to +7.0	V
DC Input Voltage (Referenced to GND)	V _{IN}	-0.5 to V _{CC} +0.5	V
DC Output Voltage	V _{OUT}	-0.5 to V _{CC} +0.5	V
DC Input Current, per pad	I _{IN}	±20	mA
DC Output Current, per pad	I _{OUT}	±25	mA
DC V _{CC} or GND Current, per pad	I _{CC}	±50	mA
Power Dissipation in Still Air ²	P _D	750	mW
Storage Temperature Range	T _{STG}	-65 to 150	°C

1. Operation above the absolute maximum rating may cause device failure. Operation at the absolute maximum ratings, for extended periods, may reduce device reliability. 2. Measured in plastic DIP package, results in die form are dependent on die attach and assembly method.

Recommended Operating Conditions³ (Voltages referenced to GND)

PARAMETER	SYMBOL	MIN	MAX	UNITS	
DC Supply Voltage	V _{CC}	2 ⁴	6	V	
DC Input or Output Voltage	V _{IN} , V _{OUT}	0	V _{CC}	V	
Operating Temperature Range	T _J	0	+85	°C	
Input Rise or Fall Times	V _{CC} = 2.0V	t _r , t _f	0	1000	ns
	V _{CC} = 4.5V		0	500	
	V _{CC} = 6.0V		0	400	

3. This device contains protection circuitry to guard against damage due to high static voltages or electric fields. However, precautions must be taken to avoid applications of any voltage higher than maximum rated voltages to this high-impedance circuit. For proper operation, V_{IN} and V_{OUT} should be constrained to the range GND ≤ (V_{IN} or V_{OUT}) ≤ V_{CC}. Unused inputs must always be tied to an appropriate logic voltage level (e.g., either GND or V_{CC}). Unused outputs must be left open.

4. The oscillator is guaranteed to function at 2.5 V minimum. However, parametrics are tested at 2.0V by driving Pad 11 with an external clock source.





High Speed CMOS Logic – 74HC4060

Rev 1.0

26/11/17

DC Electrical Characteristics (Voltages Referenced to GND)

PARAMETER	SYMBOL	V _{CC}	CONDITIONS	LIMITS			UNITS	
				25°C	85°C	FULL RANGE ⁵		
Minimum High-Level Input Voltage	V _{IH}	2.0V	V _{OUT} = 0.1V or V _{CC} -0.1V I _{OUT} ≤ 20μA	1.5	1.5	1.5	V	
		3.0V		2.1	2.1	2.1		
		4.5V		3.15	3.15	3.15		
		6.0V		4.2	4.2	4.2		
Maximum Low-Level Input Voltage	V _{IL}	2.0V	V _{OUT} = 0.1V or V _{CC} -0.1V I _{OUT} ≤ 20μA	0.5	0.5	0.5	V	
		3.0V		0.9	0.9	0.9		
		4.5V		1.35	1.35	1.35		
		6.0V		1.8	1.8	1.8		
Minimum High-Level Output Voltage (Q4–Q10, Q12–Q14)	V _{OH}	2.0V	V _{IN} = V _{IH} or V _{IL} I _{OUT} ≤ 20μA	1.9	1.9	1.9	V	
		4.5V		4.4	4.4	4.4		
		6.0V		5.9	5.9	5.9		
	V _{OH}	3.0V	V _{IN} = V _{IH} or V _{IL} I _{OUT} ≤ 2.4mA	2.48	2.34	2.34	V	
		4.5V		V _{IN} = V _{IH} or V _{IL} I _{OUT} ≤ 4.0mA	3.98	3.84		3.84
		6.0V			V _{IN} = V _{IH} or V _{IL} I _{OUT} ≤ 5.2mA	5.48		5.34
Maximum Low-Level Output Voltage (Q4–Q10, Q12–Q14)	V _{OL}	2.0V	V _{IN} = V _{IH} or V _{IL} I _{OUT} ≤ 20μA	0.1		0.1	0.1	V
		4.5V		0.1	0.1	0.1		
		6.0V		0.1	0.1	0.1		
	V _{OL}	3.0V	V _{IN} = V _{IH} or V _{IL} I _{OUT} ≤ 2.4mA	0.26	0.33	0.33	V	
		4.5V		V _{IN} = V _{IH} or V _{IL} I _{OUT} ≤ 4.0mA	0.26	0.33		0.33
		6.0V			V _{IN} = V _{IH} or V _{IL} I _{OUT} ≤ 5.2mA	0.26		0.33
Minimum High-Level Output Voltage (O _{sc} OUT1, O _{sc} OUT2)	V _{OH}	2.0V	V _{IN} = V _{CC} or GND I _{OUT} ≤ 20μA	1.9		1.9	1.9	V
		4.5V		4.4	4.4	4.4		
		6.0V		5.9	5.9	5.9		
	V _{OH}	3.0V	V _{IN} = V _{CC} or GND I _{OUT} ≤ 0.7mA	2.48	2.34	2.34	V	
		4.5V		V _{IN} = V _{CC} or GND I _{OUT} ≤ 1.0mA	3.98	3.84		3.84
		6.0V			V _{IN} = V _{CC} or GND I _{OUT} ≤ 1.3mA	5.48		5.34

5. 0°C ≤ T_J ≤ +85°C





High Speed CMOS Logic – 74HC4060

Rev 1.0
26/11/17

DC Electrical Characteristics Continued (Voltages referenced to GND)

PARAMETER	SYMBOL	V _{CC}	CONDITIONS	LIMITS			UNITS
				25°C	85°C	FULL RANGE ⁵	
Maximum Low-Level Output Voltage (O _{SC} OUT1, O _{SC} OUT2)	V _{OL}	2.0V	V _{IN} = V _{CC} or GND I _{OUT} ≤ 20μA	0.1	0.1	0.1	V
		4.5V		0.1	0.1	0.1	
		6.0V		0.1	0.1	0.1	
		3.0V	V _{IN} = V _{CC} or GND I _{OUT} ≤ 0.7mA	0.26	0.33	0.33	V
		4.5V		0.26	0.33	0.33	
		6.0V		0.26	0.33	0.33	
Maximum Input Leakage Current	I _{IN}	6.0V	V _{IN} = V _{CC} or GND	±0.1	±1.0	±1.0	μA
Maximum Quiescent Supply Current	I _{CC}	6.0V	V _{IN} = V _{CC} or GND, I _{OUT} = 0μA	4	80	80	μA

AC Electrical Characteristics⁶

PARAMETER	SYMBOL	V _{CC}	CONDITIONS	LIMITS			UNITS
				25°C	85°C	FULL RANGE ⁵	
Maximum Clock Frequency (50% Duty Cycle) (Figure 1,4)	f _{max}	2.0V	C _L = 50pF, t _r = t _f = 6ns	6	9	9	MHz
		3.0V		10	14	14	
		4.5V		30	28	28	
		6.0V		50	45	45	
Maximum Propagation Delay, O _{SC} IN to Q4 ⁷ (Figure 1,4)	t _{PLH} , t _{PHL}	2.0V	C _L = 50pF, t _r = t _f = 6ns	300	375	375	ns
		3.0V		180	200	200	
		4.5V		60	75	75	
		6.0V		51	64	64	
Maximum Propagation Delay, O _{SC} IN to Q14 ⁷ (Figure 1,4)	t _{PLH} , t _{PHL}	2.0V	C _L = 50pF, t _r = t _f = 6ns	500	750	750	ns
		3.0V		350	450	450	
		4.5V		250	275	275	
		6.0V		200	220	220	
Maximum Propagation Delay, Reset to any Q (Figure 2,4)	t _{PHL}	2.0V	C _L = 50pF, t _r = t _f = 6ns	195	245	245	ns
		3.0V		75	100	100	
		4.5V		39	49	49	
		6.0V		33	42	42	

6. Not production tested in die form, characterized by chip design and tested in package.

7. For T_J = 25°C and C_L = 50 pF, typical propagation delay from Clock to other Q outputs may be calculated with the following equations:

$$V_{CC} = 2.0 \text{ V: } t_p = [93.7 + 59.3 (n-1)] \text{ ns}$$

$$V_{CC} = 4.5 \text{ V: } t_p = [30.25 + 14.6 (n-1)] \text{ ns}$$

$$V_{CC} = 3.0 \text{ V: } t_p = [61.5 + 34.4 (n-1)] \text{ ns}$$

$$V_{CC} = 6.0 \text{ V: } t_p = [24.4 + 12 (n-1)] \text{ ns}$$





High Speed CMOS Logic – 74HC4060

Rev 1.0
26/11/17

AC Electrical Characteristics continued⁶

PARAMETER	SYMBOL	V _{CC}	CONDITIONS	LIMITS			UNITS
				25°C	85°C	FULL RANGE ⁵	
Maximum Propagation Delay, Q _n to Q _{n+1} (Figure 3,4)	t _{PLH} , t _{PHL}	2.0V	C _L = 50pF, t _r = t _f = 6ns	75	95	95	ns
		3.0V		60	75	75	
		4.5V		15	19	19	
		6.0V		13	16	16	
Maximum Output Transition Time, any output (Figure 1,4)	t _{TLH} , t _{THL}	2.0V	C _L = 50pF, t _r = t _f = 6ns	75	95	95	ns
		3.0V		27	32	32	
		4.5V		15	19	19	
		6.0V		13	16	16	
Maximum Input Capacitance	C _{IN}	-	-	10	10	10	pF
Power Dissipation Capacitance ⁸	C _{PD}	-	T _A = 25°C, V _{CC} = 5.0V	TYPICAL			pF
				35			

8. Used to determine the no-load dynamic power consumption: $P_D = C_{PD} V_{CC}^2 f + I_{CC} V_{CC}$

Timing Requirements⁶

PARAMETER	SYMBOL	V _{CC}	CONDITIONS	LIMITS			UNITS
				25°C	85°C	FULL RANGE ⁵	
Minimum Recovery Time, Reset Inactive to Clock (Figure 2)	t _{rec}	2.0V	t _r = t _f = 6ns	100	125	125	ns
		3.0V		75	100	100	
		4.5V		20	25	25	
		6.0V		17	21	21	
Minimum Pulse Width, Clock (Figure 1)	t _w	2.0V	t _r = t _f = 6ns	75	95	95	ns
		3.0V		27	32	32	
		4.5V		15	19	19	
		6.0V		13	16	16	
Minimum Pulse Width, Reset (Figure 2)	t _w	2.0V	t _r = t _f = 6ns	75	95	95	ns
		3.0V		27	32	32	
		4.5V		15	19	19	
		6.0V		13	16	16	
Maximum Input Rise and Fall Times (Figure 1)	t _r , t _f	2.0V	t _r = t _f = 6ns	1000	1000	1000	ns
		3.0V		800	800	800	
		4.5V		500	500	500	
		6.0V		400	400	400	





High Speed CMOS Logic – 74HC4060

Rev 1.0
26/11/17

Switching Waveforms

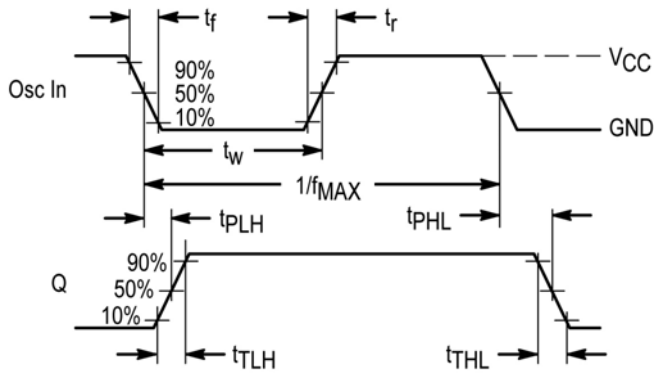

Figure 1 – Input to Output Propagation Delay & Timing

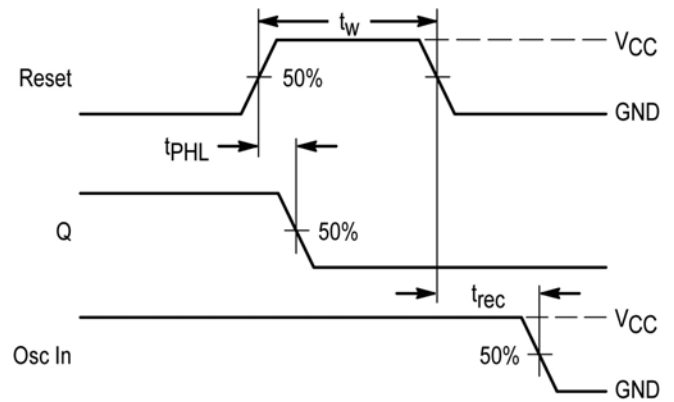

Figure 2 – Reset Timing

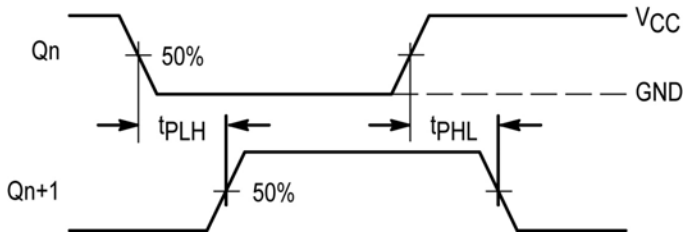
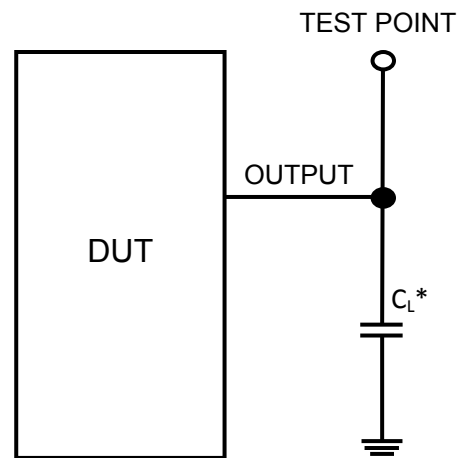

Figure 3 – Ripple output timing

Test Circuit



* Includes all probe and jig capacitance

Figure 4 – Test Setup

DISCLAIMER: The information given in this document shall in no event be regarded as a guarantee of conditions or characteristics. With respect to any examples or hints given herein, any typical values stated herein and/or any information regarding the application of the device, Silicon Supplies Ltd hereby disclaims any and all warranties and liabilities of any kind.

LIFE SUPPORT POLICY: Silicon Supplies Ltd components may be used in life support devices or systems only with the express written approval of Silicon Supplies Ltd, if a failure of such components can reasonably be expected to cause the failure of that life support device or system or to affect the safety or effectiveness of that device or system. Life support devices or systems are intended to be implanted in the human body or to support and/or maintain and sustain and/or protect human life. If they fail, it is reasonable to assume that the health of the user or other persons may be endangered.

