



NPN Transistor Bare Die, 2N708

Rev 1.0
02/09/17

Very High Speed Saturated Switch in bare die form
Complement PNP 2N4209 or 2N5771

Features:

- Collector current up to 200mA
- Fast $t_{on} + t_{off}$ switching times
- Characterized at temperature extremes
- High Reliability Gold Back Metal
- High Reliability tested grades for Military + Space

Ordering Information:

The following part suffixes apply:

- No suffix - MIL-STD-750 /2072 Visual Inspection
- "H" - MIL-STD-750 /2072 Visual Inspection
+ MIL-PRF-38534 Class H LAT
- "K" - MIL-STD-750 /2072 Visual Inspection
+ MIL-PRF-38534 Class K LAT

LAT = Lot Acceptance Test.

For further information on LAT process flows see below.

www.siliconsupplies.com/quality/bare-die-lot-qualification

Die Dimensions in μm (mils)

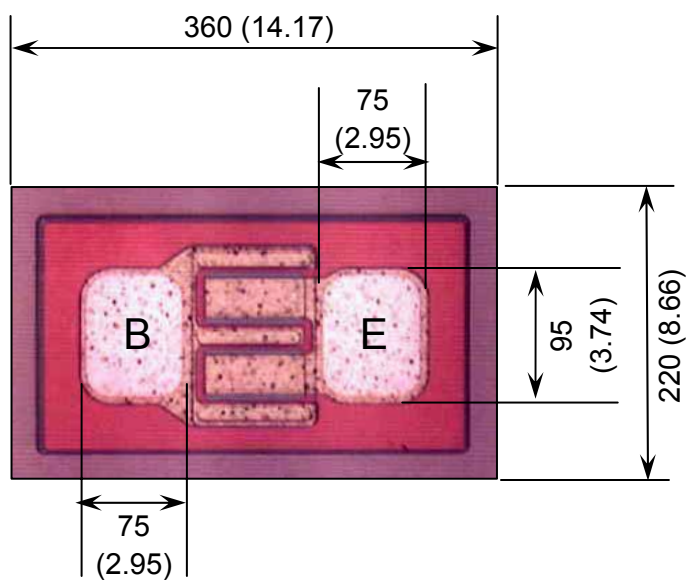

E = EMITTER B = BASE
DIE BACK = COLLECTOR

Supply Formats:

- Default – Die in Waffle Pack (400 per tray capacity)
- Sawn Wafer on Tape – Specific request
- Unsawn Wafer – Specific request
- With additional electrical selection – Specific request
- Sawn as pairs or adjacent pair pick – Specific request

Mechanical Specification

Die Size (Excluding Saw Street)	360 x 220 14.17 x 8.66	μm mils
Base Pad Size Emitter Pad Size	75 x 95 2.95 x 3.74	μm mils
Die Thickness	180 (± 20) 7.09 (± 0.79)	μm mils
Top Metal Composition	Al - 1.3 μm	
Back Metal Composition	AuAs - 0.9 μm	





NPN Transistor Bare Die, 2N708

Rev 1.0
07/07/17

Absolute Maximum Ratings $T_A = 25^\circ\text{C}$ unless otherwise stated

PARAMETER	SYMBOL	VALUE	UNIT
Collector-Base Voltage	V_{CBO}	40	V
Collector-Emitter Voltage	V_{CEO}	15	V
Emitter-Base Voltage	V_{EBO}	5	V
Collector Current	I_C	200	mA
Junction & Storage Temperature	T_J, T_{stg}	-55 to 150	$^\circ\text{C}$

Electrical Characteristics $T_A = 25^\circ\text{C}$ unless otherwise stated

PARAMETER	SYMBOL	CONDITIONS	MIN	TYP	MAX	UNIT
OFF CHARACTERISTICS						
Collector-Base Breakdown Voltage	$V_{(BR)CBO}$	$I_C = 1\mu\text{A}, I_E = 0$	40	-	-	V
Collector-Emitter Breakdown Voltage	$V_{CEO(sus)}$	$I_C = 30\text{mA}, I_B = 0$	15	-	-	V
Collector-Emitter Breakdown Voltage	$V_{CER(sus)}$	$I_C = 30\text{mA}, R_{BE} \leq 10\Omega$	20	-	-	V
Emitter-Base Breakdown Voltage	$V_{(BR)EBO}$	$I_E = 10\mu\text{A}, I_C = 0$	5	-	-	V
Collector Cutoff Current	I_{CEX}	$T_A = +125^\circ\text{C}, V_{CE} = 20\text{V}, V_{BE} = 0.25\text{V}$	-	-	10	μA
	I_{CBO}	$V_{CB} = 20\text{V}, I_E = 0\text{V}$	-	-	25	nA
		$T_A = +150^\circ\text{C}, V_{CB} = 20\text{V}, I_E = 0\text{V}$	-	-	15	μA
ON CHARACTERISTICS						
Forward-Current Transfer Ratio	h_{FE}	$V_{CE} = 01\text{V}, I_C = 0.5\text{mA}$	15	-	-	-
		$V_{CE} = 1\text{V}, I_C = 10\text{mA}$	30	-	120	-
		$T_A = -55^\circ\text{C}, V_{CE} = 1\text{V}, I_C = 10\text{mA}$	15	-	-	-
Collector-Emitter Saturation Voltage	$V_{CE(sat)}$	$I_C = 10\text{mA}, I_B = 1\text{mA}$	-	-	0.4	V
		$T_A = -55 \text{ to } +125^\circ\text{C}, I_C = 7\text{mA}, I_B = 0.7\text{mA}$	-	-	0.4	V
Base-Emitter Saturation Voltage	$V_{BE(sat)}$	$I_C = 10\text{mA}, I_B = 1\text{mA}$	0.72	-	0.80	V
		$T_A = -55, I_C = 7\text{mA}, I_B = 0.7\text{mA}$	-	-	0.90	V
SMALL SIGNAL CHARACTERISTICS¹						
Current Gain – Bandwidth Product	f_T	$I_C = 10\text{mA}, V_{CE} = 10\text{V}, f = 100\text{MHz}$	300	-	-	MHz
Output Capacitance	C_{obo}	$V_{CB} = 5\text{V}, I_E = 0, f = 1\text{MHz}$	-	-	4	pF
Input Capacitance	C_{ibo}	$V_{EB} = 0.5\text{V}, I_C = 0, f = 1\text{MHz}$	-	-	5	
SWITCHING CHARACTERISTICS¹						
Turn-On Time	t_{on}	-	-	-	40	ns
Turn-Off Time	t_{off}	-	-	-	70	
Storage Time	t_s	$I_{B1} = I_{B1} = I_C = 10\text{mA}$	-	-	25	

Note 1: Not production testing in die form, characterized by chip design and tested in package LAT





NPN Transistor Bare Die, 2N708

Rev 1.0
07/07/17

Typical Electrical Characteristics

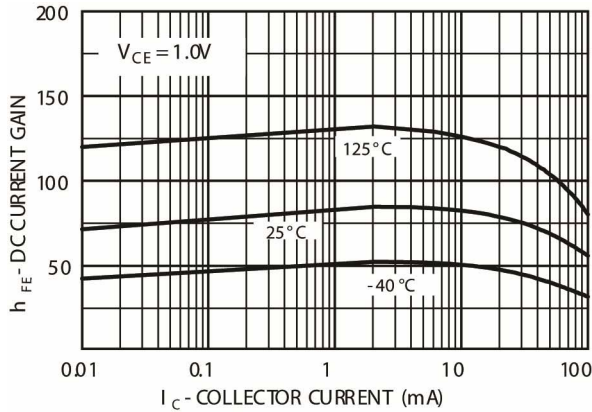

Fig 1 - DC Current Gain versus Collector Current

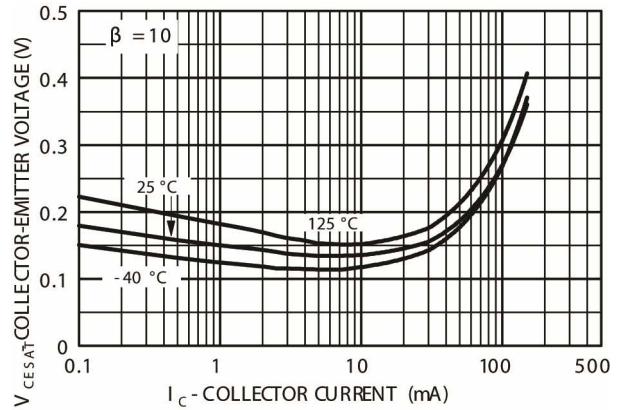

Fig 2 - Collector-Emitter Saturation Voltage versus Collector Current

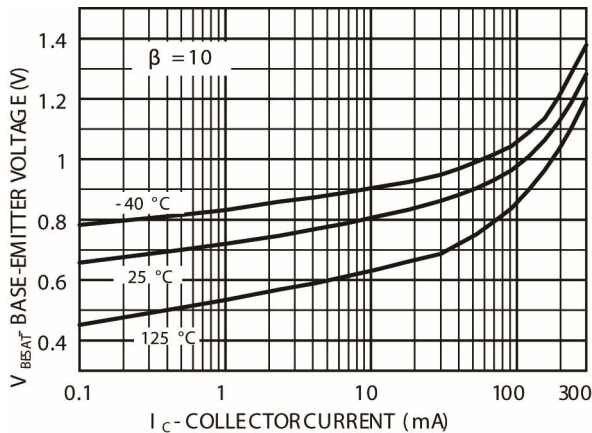

Fig 3 - Base-Emitter Saturation Voltage versus Collector Current

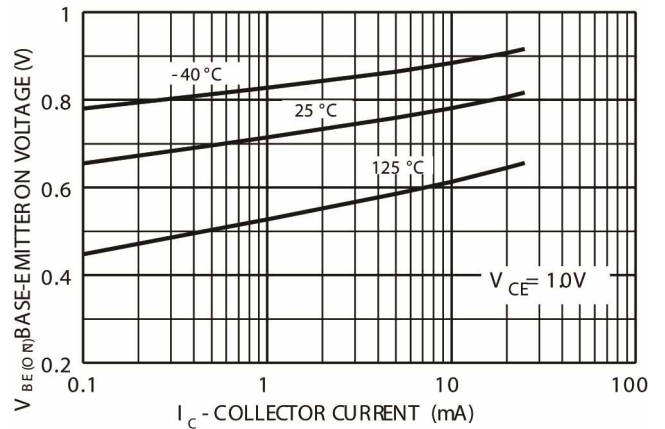

Fig 4 - Base-Emitter ON Voltage versus Collector Current

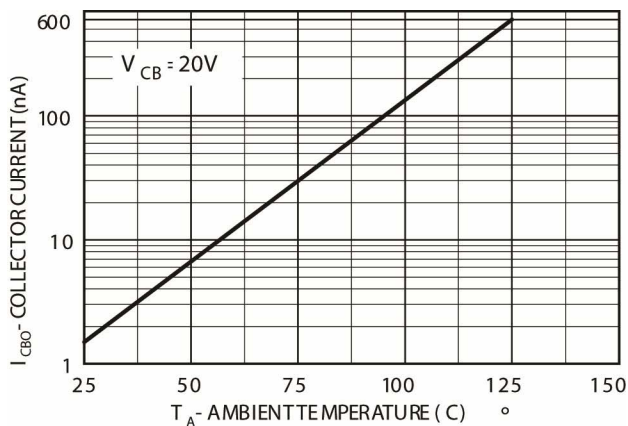

Fig 5 - Collector-Cut-off Current versus Ambient Temperature

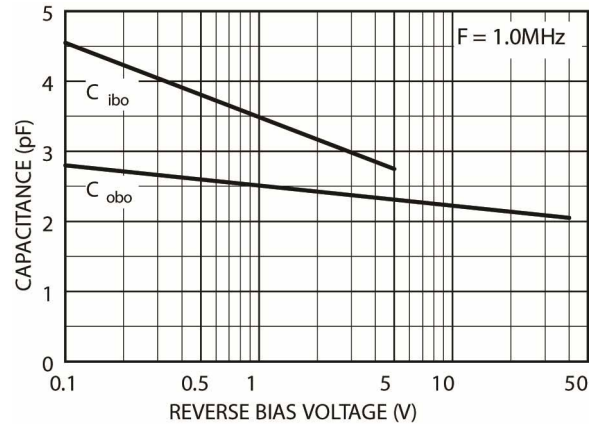

Fig 6 - Output Capacitance versus Reverse Bias Voltage





NPN Transistor Bare Die, 2N708

Rev 1.0
07/07/17

Typical Electrical Characteristics (Continued)

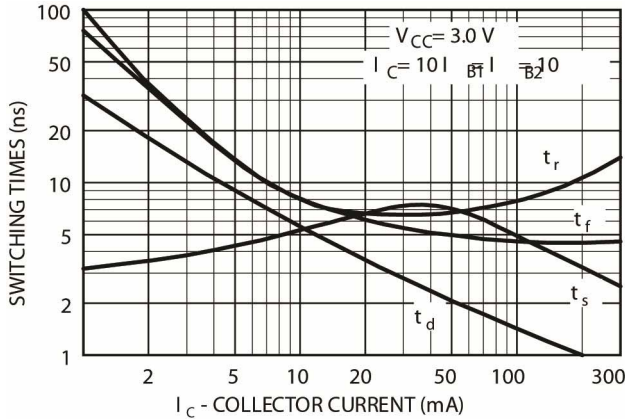

Fig 7 - Switching Times versus Collector Current

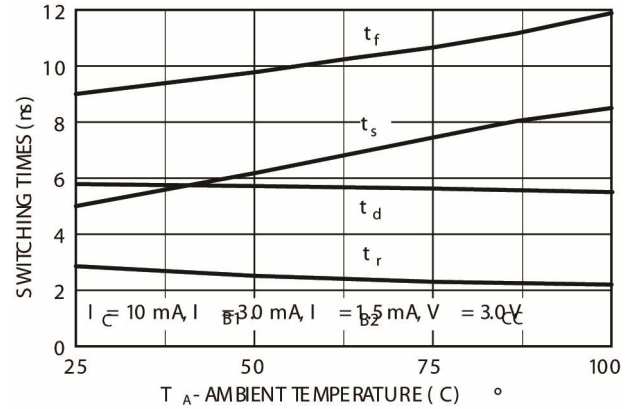

Fig 8 - Switching Times versus Ambient Temperature

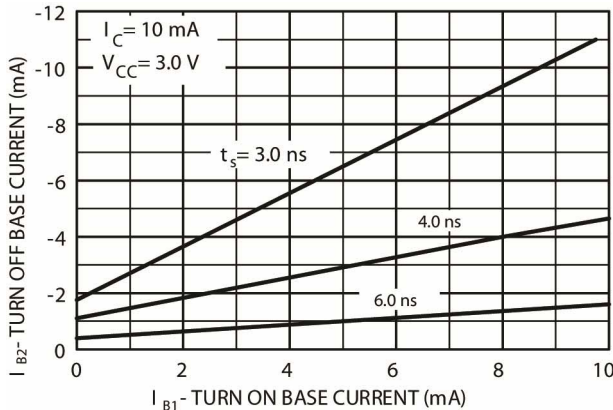

Fig 8 - Storage Time versus Turn On and Turn Off Base Currents

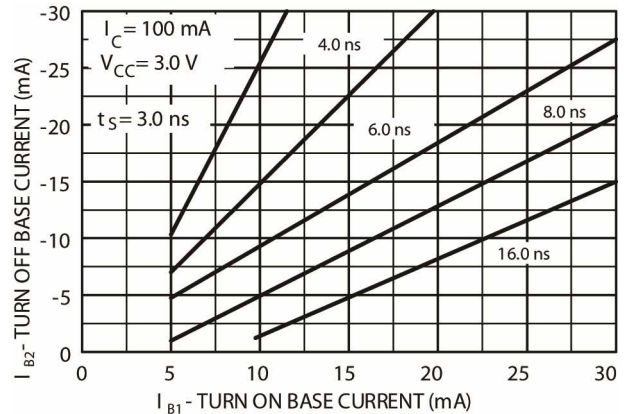

Fig 9 - Storage Time versus Turn On and Turn Off Base Currents

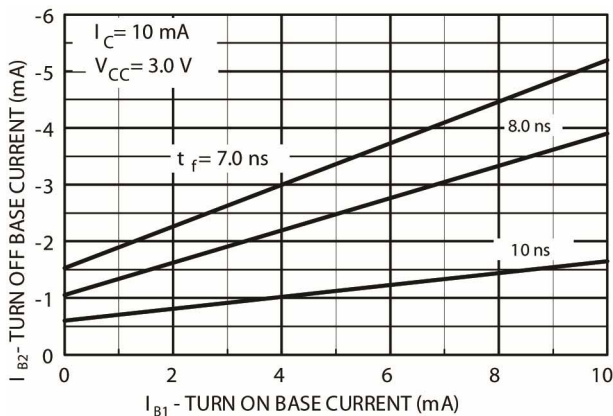

Fig 10 - Fall Time versus Turn On and Turn Off Base Currents

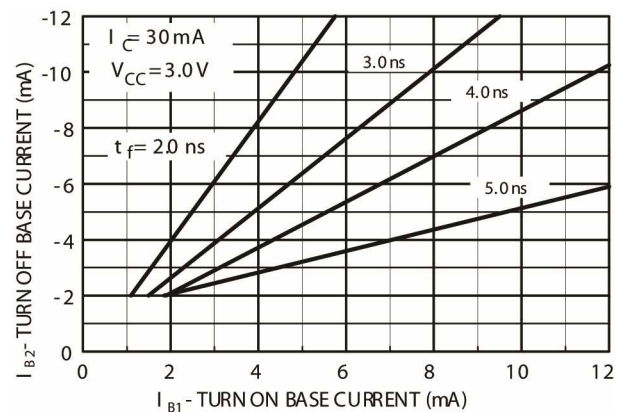

Fig 11 - Fall Time versus Turn On and Turn Off Base Currents





NPN Transistor Bare Die, 2N708

Rev 1.0
07/07/17

Typical Electrical Characteristics (Continued)

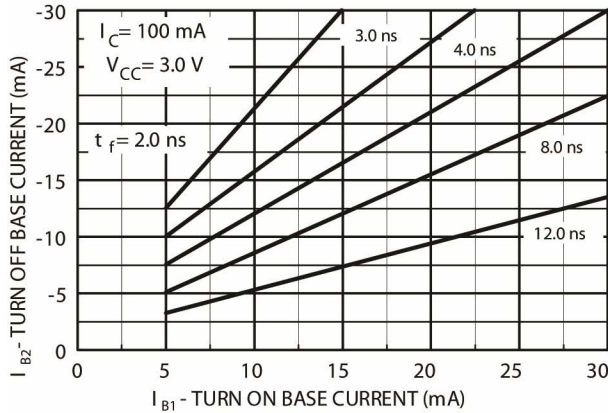

Fig 12 - Fall Time versus Turn On and Turn Off Base Currents

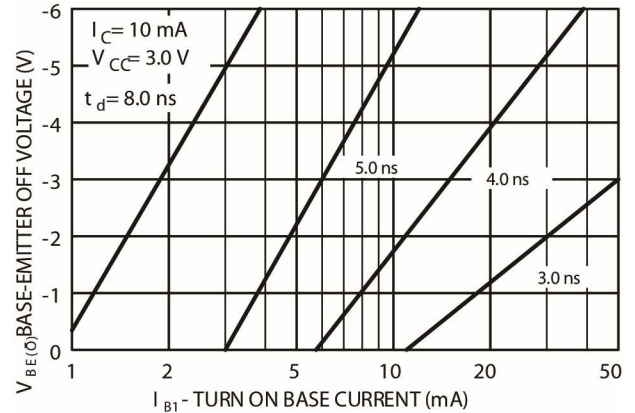

Fig 13 - Delay Time versus Base-Emitter Off Voltage and Turn On Base Current

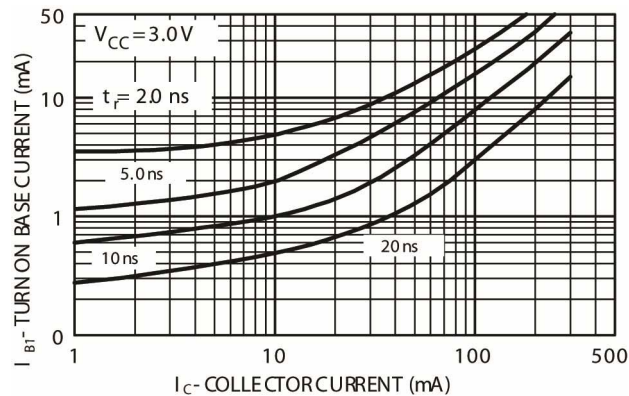

Fig 14 - Rise Time vs. Turn On Base Current and Collector Current

DISCLAIMER: The information given in this document shall in no event be regarded as a guarantee of conditions or characteristics. With respect to any examples or hints given herein, any typical values stated herein and/or any information regarding the application of the device, Silicon Supplies Ltd hereby disclaims any and all warranties and liabilities of any kind.

LIFE SUPPORT POLICY: Silicon Supplies Ltd components may be used in life support devices or systems only with the express written approval of Silicon Supplies Ltd, if a failure of such components can reasonably be expected to cause the failure of that life support device or system or to affect the safety or effectiveness of that device or system. Life support devices or systems are intended to be implanted in the human body or to support and/or maintain and sustain and/or protect human life. If they fail, it is reasonable to assume that the health of the user or other persons may be endangered.

