

Thin Film, Center-Tapped Resistor Divider Network

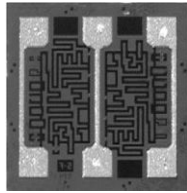

Product may not be to scale

LINKS TO ADDITIONAL RESOURCES



The CTR series is a center-tapped resistor chip combining excellent stability with 250 mW power levels. The CTR offers the designer flexibility in use as either a single value resistor as two resistors with a center tap feature. The CTR's six bonding pads allows the user increased layout flexibility.

The CTRs are manufactured using Vishay Electro-Films (EFI) sophisticated thin film equipment and manufacturing technology. The CTRs are 100 % electrically tested and visually inspected to MIL-STD-883, method 2032 class H or K.

FEATURES

- Wire bondable
- Center tap feature
- Tight ratio tolerances to: 0.05 %
- Chip size: 0.030" x 0.030"
- Case: 0303
- Resistance range total: 10 Ω to 1 MΩ
- Oxidized silicon substrate for good power dissipation
- Moisture resistant
- Resistor material: tantalum nitride, self-passivating
- Material categorization: for definitions of compliance please see www.vishay.com/doc?99912



RoHS
COMPLIANT
HALOGEN
FREE
GREEN
(5-2008)

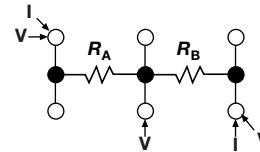

APPLICATIONS

Vishay EFI CTR center-tapped resistor chips are used mainly in feedback circuits of amplifiers where ratio matching, high power and tracking between two resistors is critical.

For low values, the resistance of the six bonding-pad configurations can vary, depending on the method of measurement used. Vishay EFI measures low-value resistors by the four wire Kelvin technique. The method illustrated above is critical for resistors of less than 100 Ω.

TEMPERATURE COEFFICIENT OF RESISTANCE, VALUES, AND TOLERANCES

PARAMETER	VALUE	UNIT
Total Resistance Range	10 to 1M	Ω
Standard Tolerances	± 0.1, ± 0.5	%
TCR	± 25, ± 50, ± 100	ppm/°C

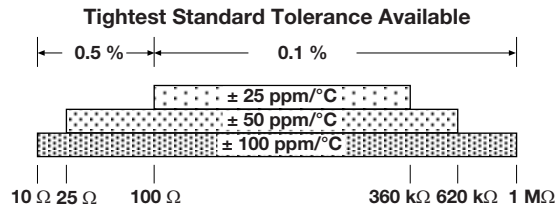

STANDARD ELECTRICAL SPECIFICATIONS

PARAMETER	VALUE	UNIT
TCR Tracking Between Halves (R_A/R_B) ⁽¹⁾	± 2	ppm/°C
Center Tap Ratio, R_A/R_B : Tolerance	1 ± 1 standard	%
Noise, MIL-STD-202, Method 308, < 100 Ω or > 251 kΩ	-20 typ.	dB
Moisture Resistance, MIL-STD-202, Method 106	± 0.5 max. $\Delta R/R$	%
Stability, 1000 h, +125 °C, 125 mW	± 0.2 max. absolute	%
Operating Temperature Range	-55 to +150	°C
Thermal Shock, MIL-STD-202, Method 107, Test Condition F	± 0.1 max. $\Delta R/R$	%
High Temperature Exposure, +150 °C, 100 h	± 0.2 max. $\Delta R/R$	%
Dielectric Voltage Breakdown	200	V
Insulation Resistance	10 ¹² min.	Ω
Operating Voltage	100 max.	V
DC Power Rating at 70 °C (derated to Zero at +175 °C)	0.25 max.	W
5x Rated Power Short-Time Overload, +25 °C, 5 s	± 0.1 max. $\Delta R/R$	%

Note

⁽¹⁾ 5 ppm/°C for $R < 100$. 20 ppm/°C for $R < 20$

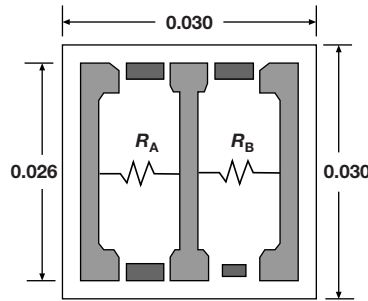
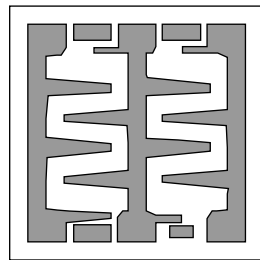
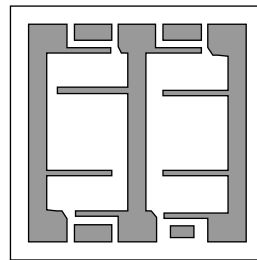
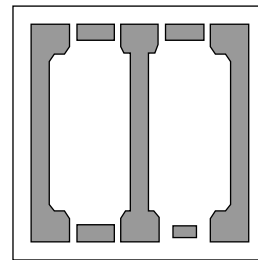
DIMENSIONS in inches

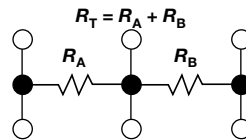
STANDARD CONFIGURATION
 Six locations. All pads 0.005" x 0.005"

TYPICAL RANGE
 10 Ω to 26.9 Ω

TYPICAL RANGE
 27 Ω to 99 Ω

TYPICAL RANGE
 100 Ω to 1 MΩ

SCHEMATIC

MECHANICAL SPECIFICATIONS	
PARAMETER	VALUE
Chip Size	0.030" x 0.030" ± 0.002" (0.762 mm x 0.762 mm ± 0.05 mm)
Chip Thickness	0.010" ± 0.002" (0.254 mm ± 0.05 mm)
Chip Substrate Material	Oxidized silicon, 10 kÅ minimum SiO ₂
Resistor Material	Tantalum nitride, self-passivating
Bonding Pad Size	0.005" x 0.005" (0.127 mm x 0.127 mm) min.
Number of Pads	6
Pad Material	10 kÅ minimum aluminum
Backing	None, lapped semiconductor silicon

GLOBAL PART NUMBER INFORMATION																
Global Part Number: CTR5000KFKGNHWS																
Global Part Number Description: CTR 5K 10 %, RT 1 %, 100 ppm/°C, TC track 10, Au, no back metal, class H, WS																
C	T	R	5	0	0	0	0	K	F	K	K	G	N	H	W	S
MODEL	RESISTANCE (R TOTAL)	RESISTANCE MULTIPLIER CODE	TOL. CODE (%)	RATIO TOL.	TCR (ppm/°C)	TC TRACK (ppm/°C)	TERMINATION	BACK METAL	VISUAL CLASS	PACKAGING CODE						
CTR	First 4 digits are significant figures of resistance	C = 0.001 B = 0.01 A = 0.1 0 = 1 1 = 10 2 = 100 3 = 1000	B = 0.1 C = 0.25 D = 0.5 F = 1.0 G = 2.0 J = 5.0 K = 10 M = 20	B = 0.1 C = 0.25 D = 0.5 F = 1.0 G = 2.0 J = 5.0 N = No	E = ± 25 C = ± 50 K = ± 100 M = ± 250	G = ± 2 J = ± 5 K = ± 10 N = No	G = Au A = Al	G = Au N = none	H = class H K = class K	WS = waffle pack 100 min, 1 mult.						



Disclaimer

ALL PRODUCT, PRODUCT SPECIFICATIONS AND DATA ARE SUBJECT TO CHANGE WITHOUT NOTICE TO IMPROVE RELIABILITY, FUNCTION OR DESIGN OR OTHERWISE.

Vishay Intertechnology, Inc., its affiliates, agents, and employees, and all persons acting on its or their behalf (collectively, "Vishay"), disclaim any and all liability for any errors, inaccuracies or incompleteness contained in any datasheet or in any other disclosure relating to any product.

Vishay makes no warranty, representation or guarantee regarding the suitability of the products for any particular purpose or the continuing production of any product. To the maximum extent permitted by applicable law, Vishay disclaims (i) any and all liability arising out of the application or use of any product, (ii) any and all liability, including without limitation special, consequential or incidental damages, and (iii) any and all implied warranties, including warranties of fitness for particular purpose, non-infringement and merchantability.

Statements regarding the suitability of products for certain types of applications are based on Vishay's knowledge of typical requirements that are often placed on Vishay products in generic applications. Such statements are not binding statements about the suitability of products for a particular application. It is the customer's responsibility to validate that a particular product with the properties described in the product specification is suitable for use in a particular application. Parameters provided in datasheets and / or specifications may vary in different applications and performance may vary over time. All operating parameters, including typical parameters, must be validated for each customer application by the customer's technical experts. Product specifications do not expand or otherwise modify Vishay's terms and conditions of purchase, including but not limited to the warranty expressed therein.

Except as expressly indicated in writing, Vishay products are not designed for use in medical, life-saving, or life-sustaining applications or for any other application in which the failure of the Vishay product could result in personal injury or death. Customers using or selling Vishay products not expressly indicated for use in such applications do so at their own risk. Please contact authorized Vishay personnel to obtain written terms and conditions regarding products designed for such applications.

No license, express or implied, by estoppel or otherwise, to any intellectual property rights is granted by this document or by any conduct of Vishay. Product names and markings noted herein may be trademarks of their respective owners.