



Monolithic Transistor Array – SiS3046

Silicon General Purpose x5 NPN Transistor array in bare die form

Rev 1.1
20/10/17

Description

The SiS3046 consists of five general purpose silicon NPN transistors on a common monolithic substrate. Two of the transistors are internally connected to form a differentially-connected pair. The transistors are well suited to a wide variety of applications in low power systems in the DC through VHF range. They may be used as discrete transistors in conventional circuits however; in addition, they provide the very significant inherent integrated circuit advantages of close electrical and thermal matching. The SiS3046 is a direct electrical & mechanical replacement for the obsolete Intersil CA3046 & National (TI) LM3046.

Features:

- Two matched transistors:
 - V_{BE} Match $\pm 5\text{mA}$
 - I_{IO} Match $2\mu\text{A}$ (Max)
- Low Noise Figure 3.2dB (Typ) at 1kHz
- Operation From DC to 20MHz
- Wide Operating Current Range
- Full Military Temperature Range.

Ordering Information

The following part suffixes apply:

- No suffix - MIL-STD-883 /2010B Visual Inspection
- “H” - MIL-STD-883 /2010B Visual Inspection
+ MIL-PRF-38534 Class H LAT
- “K” - MIL-STD-883 /2010A Visual Inspection (Space)
+ MIL-PRF-38534 Class K LAT

LAT = Lot Acceptance Test.

For further information on LAT process flows see below.

www.siliconsupplies.com/quality/bare-die-lot-qualification

Die Dimensions in μm (mils)

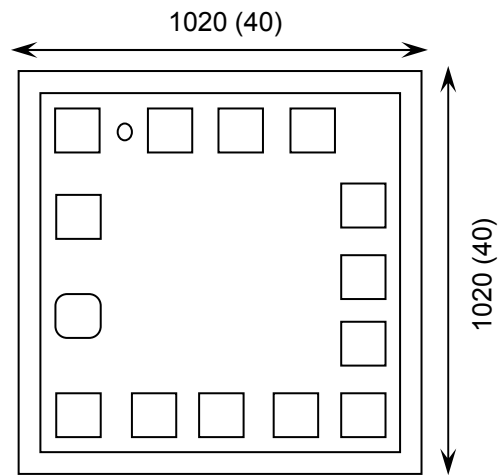

Supply Formats:

- Default - Die in Waffle Pack (400 per tray capacity)
- Sawn Wafer on Tape – By specific request
- Unsawn Wafer – By specific request
- 14 Lead CERDIP / PDIP package – By specific request
- 14 Lead SOIC package – By specific request

Mechanical Specification

| | | |
|------------------------|--|-----------------------|
| Die Size (Unsawn) | 1020 x 1020 40 x 40 | μm mils |
| Minimum Bond Pad Size | 100 x 100 4 x 4 | μm mils |
| Die Thickness | 460 18.1 | μm mils |
| Top Metal Composition | TiW-AlSi 0.15 μm -3 μm | |
| Back Metal Composition | N/A – Bare Si | |





Monolithic Transistor Array – SiS3046

Rev 1.1
20/10/17

Pad Layout and Functions

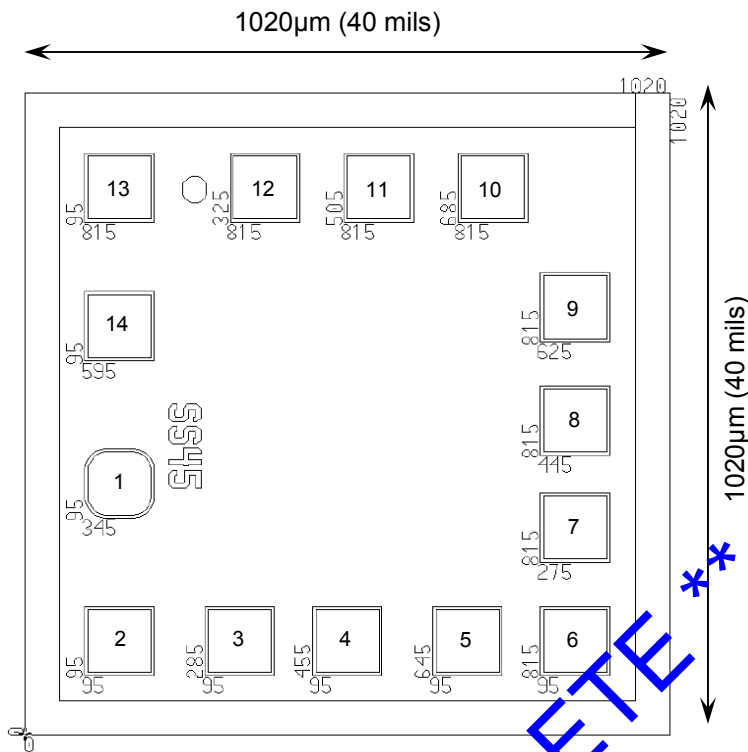

| PAD | FUNCTION |
|-----|------------------------|
| 1 | COLLECTOR Q1 |
| 2 | BASE Q1 |
| 3 | EMITTERS Q1 & Q2 |
| 4 | BASE Q2 |
| 5 | COLLECTOR Q2 |
| 6 | BASE Q3 |
| 7 | EMITTER Q3 |
| 8 | COLLECTOR Q3 |
| 9 | BASE Q4 |
| 10 | EMITTER Q4 |
| 11 | COLLECTOR Q4 |
| 12 | BASE Q5 |
| 13 | EMITTER Q5 & SUBSTRATE |
| 14 | COLLECTOR Q5 |

Die backside must be connected to the most negative point in the external circuit to maintain isolation between transistors and to provide for normal transistor action.

Circuit Schematic

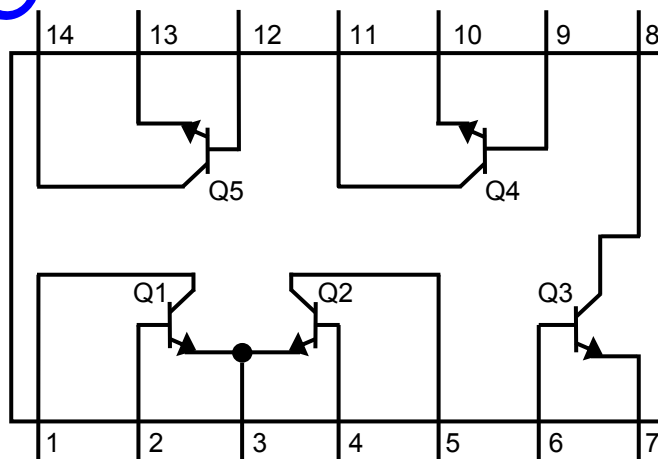



Monolithic Transistor Array – SiS3046

Rev 1.1
20/10/17

Absolute Maximum Ratings

| PARAMETER | SYMBOL | VALUE | UNIT |
|--|-----------|------------|------|
| Collector-to-Emitter Voltage | V_{CEO} | 15 | V |
| Collector-to-Base Voltage | V_{CBO} | 20 | V |
| Collector-to-Substrate Voltage (Note 1) | V_{CIO} | 20 | V |
| Emitter-to-Base Voltage | V_{EBO} | 5 | V |
| Collector Current | I_C | 50 | mA |
| Maximum Power Dissipation (Any one transistor) | P_D | 300 | mW |
| Operating Temperature Range | - | -55 to 125 | °C |
| Maximum Junction Temperature | T_J | 75 | °C |

DC Electrical Characteristics $T_A = 25^\circ\text{C}$ unless otherwise stated

| PARAMETER | SYMBOL | TEST CONDITIONS | MIN | TYP | MAX | UNITS |
|---|---|--|-----|-------|-----|------------------------------|
| Collector to Base Breakdown Voltage | $V_{(BR)CBO}$ | $I_C = 10\mu\text{A}, I_E = 0$ | 20 | 60 | - | V |
| Collector to Emitter Breakdown Voltage | $V_{(BR)CEO}$ | $I_C = 1\text{mA}, I_B = 0$ | 15 | 24 | - | V |
| Collector-to-Substrate Breakdown Voltage | $V_{(BR)CIO}$ | $I_C = 10\mu\text{A}, I_{CI} = 0$ | 20 | 60 | - | V |
| Emitter to Base Breakdown Voltage | $V_{(BR)EBO}$ | $I_E = 10\mu\text{A}, I_C = 0$ | 5 | 7 | - | V |
| Collector Cutoff Current | I_{CBO} | $V_{CB} = 10\text{V}, I_E = 0$ | - | 0.002 | 40 | nA |
| Collector Cutoff Current (Figure 2) | I_{CEO} | $V_{CE} = 10\text{V}, I_B = 0$ | - | FIG 2 | 0.5 | μA |
| Forward Current Transfer Ratio (Static Beta) (Note 3) (Figure 3) | β_{FE} | $I_C = 10\text{mA}$ | - | 100 | - | - |
| | | $I_C = 1\text{mA}$ | 40 | 100 | - | - |
| | | $I_C = 10\mu\text{A}$ | - | 54 | - | - |
| Input Offset Current for Matched Pair Q1 and Q2. (Note 2) (Figure 4) | $ I_{O1} - I_{O2} $ | $V_{CE} = 3\text{V}, I_C = 1\text{mA}$ | - | 0.3 | 2 | μA |
| Base-to-Emitter Voltage (Note 3) (Figure 5) | V_{BE} | $I_E = 1\text{mA}$ | - | 0.715 | - | V |
| | | $I_E = 10\text{mA}$ | - | 0.800 | - | |
| Magnitude of Input Offset Voltage for Differential Pair (Note 2) (Figures 5, 7) | $ V_{BE1} - V_{BE2} $ | $V_{CE} = 3\text{V}, I_C = 1\text{mA}$ | - | 0.45 | 5 | mV |
| Magnitude of Input Offset Voltage for Isolated Transistors. (Note 2) (Figures 6, 7) | $ V_{BE3} - V_{BE4} $ $ V_{BE4} - V_{BE5} $ $ V_{BE5} - V_{BE3} $ | $V_{CE} = 3\text{V}, I_C = 1\text{mA}$ | - | 0.45 | 5 | mV |
| | | | - | - | - | - |
| | | | - | - | - | - |
| Temperature Coefficient of Base-to-Emitter Voltage (Figure 6) | $\frac{\Delta V_{BE}}{\Delta T}$ | $V_{CE} = 3\text{V}, I_C = 1\text{mA}$ | - | -1.9 | - | $\text{mV}/^\circ\text{C}$ |
| Collector-to-Emitter Saturation Voltage | V_{CES} | $I_B = 1\text{mA}, I_C = 10\text{mA}$ | - | 0.23 | - | V |
| Temperature Coefficient: Magnitude of Input Offset Voltage (Figure 7) | $\frac{ \Delta V_{IO} }{\Delta T}$ | $V_{CE} = 3\text{V}, I_C = 1\text{mA}$ | - | 1.1 | - | $\mu\text{V}/^\circ\text{C}$ |

Notes: **1.** The collector of each transistor is isolated from the substrate by an integral diode. The substrate (Terminal 13) must be connected to the most negative point in the external circuit to maintain isolation between transistors and to provide for normal transistor action. **2.** Actual forcing current is via the emitter for this test.





Monolithic Transistor Array – SiS3046

Rev 1.1

20/10/17

Dynamic Electrical Characteristics $T_A = 25^\circ\text{C}$ unless otherwise stated

| PARAMETER | SYMBOL | TEST CONDITIONS | MIN | TYP | MAX | UNITS |
|---|----------|--|-----|----------------------|-----|------------------|
| Low Frequency Noise Figure (Figure 9) | NF | $f = 1 \text{ kHz}$, $V_{CE} = 3\text{V}$ $I_C = 100\mu\text{A}$, Source Resistance = $1\text{k}\Omega$ | - | 3.25 | - | dB |
| Low Frequency, Small Signal Equivalent Circuit Characteristics | | | | | | |
| Forward Current Transfer Ratio (Figure 11) | h_{FE} | $f = 1 \text{ kHz}$ $V_{CE} = 3\text{V}$, $I_C = 1\text{mA}$ | - | 10 | - | - |
| Short Circuit Input Impedance (Figure 11) | h_{iE} | $f = 1 \text{ kHz}$ $V_{CE} = 3\text{V}$, $I_C = 1\text{mA}$ | - | 9.5 | - | $\text{k}\Omega$ |
| Open Circuit Output Impedance (Figure 11) | h_{oE} | $f = 1 \text{ kHz}$ $V_{CE} = 3\text{V}$, $I_C = 1\text{mA}$ | - | 15.6 | - | μmho |
| Open Circuit Reverse Voltage Transfer Ratio (Figure 11) | h_{rE} | $f = 1 \text{ kHz}$ $V_{CE} = 3\text{V}$, $I_C = 1\text{mA}$ | - | 1.8×10^{-4} | - | - |
| Admittance Characteristics | | | | | | |
| Forward Transfer Admittance (Figure 12) | Y_{FE} | $f = 1 \text{ kHz}$ $V_{CE} = 3\text{V}$, $I_C = 1\text{mA}$ | - | $31 - j1.5$ | - | - |
| Input Admittance (Figure 13) | Y_{iE} | $f = 1 \text{ kHz}$ $V_{CE} = 3\text{V}$, $I_C = 1\text{mA}$ | - | $0.3 + j0.04$ | - | - |
| Output Admittance (Figure 14) | Y_{oE} | $f = 1 \text{ kHz}$ $V_{CE} = 3\text{V}$, $I_C = 1\text{mA}$ | - | $0.001 + j0.03$ | - | - |
| Reverse Transfer Admittance (Figure 15) | Y_{rE} | $f = 1 \text{ kHz}$ $V_{CE} = 3\text{V}$, $I_C = 1\text{mA}$ | - | Fig 14 | - | - |
| Gain Bandwidth Product (Figure 16) | f_T | $V_{CE} = 3\text{V}$, $I_C = 1\text{mA}$ | 300 | 550 | - | MHz |
| Emitter-to-Base Capacitance | C_{EB} | $V_{EB} = 3\text{V}$, $I_E = 0$ | - | 0.6 | - | pF |
| Collector-to-Base Capacitance | C_{CB} | $V_{CB} = 3\text{V}$, $I_C = 0$ | - | 0.58 | - | pF |
| Collector-to-Substrate Capacitance | C_{CI} | $V_{CS} = 3\text{V}$, $I_C = 0$ | - | 2.8 | - | pF |

Typical Performance Characteristics

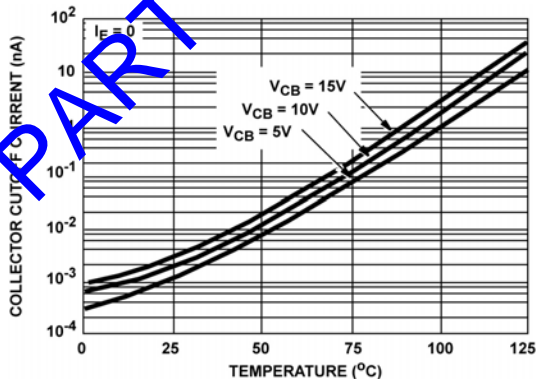

FIGURE 1. Typical Base-To-Collector Current vs Temperature (each transistor)

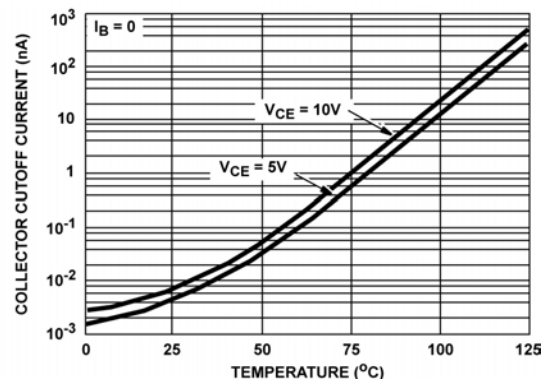

FIGURE 2. Typical Collector-To-Emitter Cutoff Current vs Temperature (each transistor)





Monolithic Transistor Array – SiS3046

Rev 1.1
20/10/17

Typical Performance Characteristics (Continued)

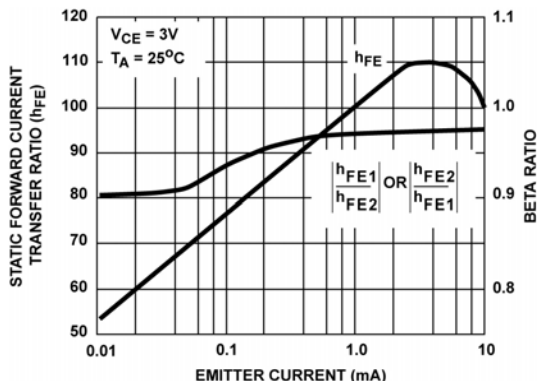

FIGURE 3. Typical Static Forward Current Transfer Ratio & Beta Ratio for Q₁ and Q₂ vs Emitter Current

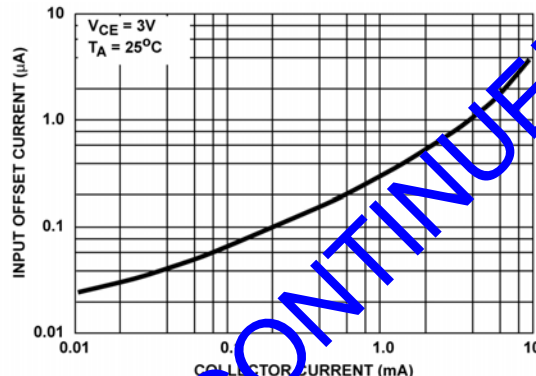

FIGURE 4. Typical Input Offset Current for matched transistor pair Q₁Q₂ vs Collector Current

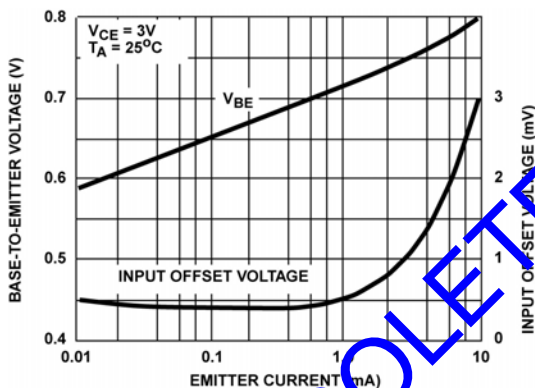

FIGURE 5. Typical static Base-to-Emitter Voltage characteristics and Input Offset Voltage for differential pair and paired isolated transistors vs Emitter Current

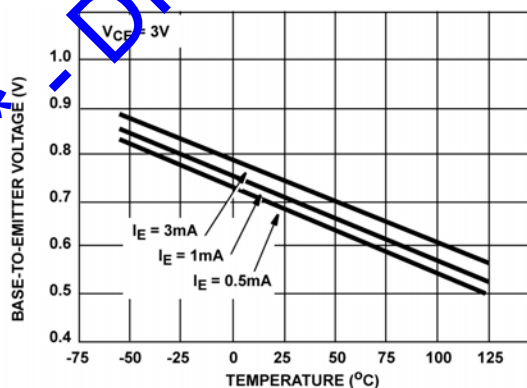

FIGURE 6. Typical Base-to-Emitter Voltage characteristic vs Temperature for each transistor.

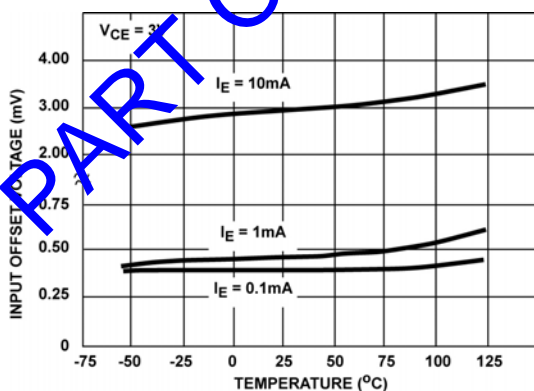

FIGURE 7. Typical Input Offset Voltage characteristics for differential pair and paired isolated transistors vs Temperature

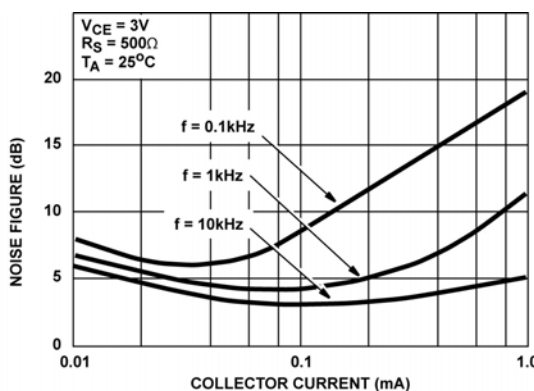

FIGURE 8. Typical Noise Figure vs Collector Current





Monolithic Transistor Array – SiS3046

Rev 1.1
20/10/17

Typical Performance Characteristics (Continued)

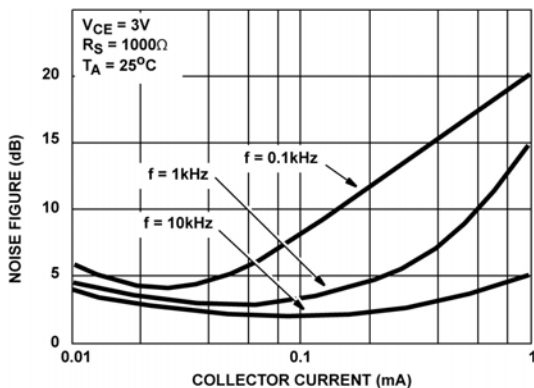

FIGURE 9. Typical Noise Figure vs Collector Current

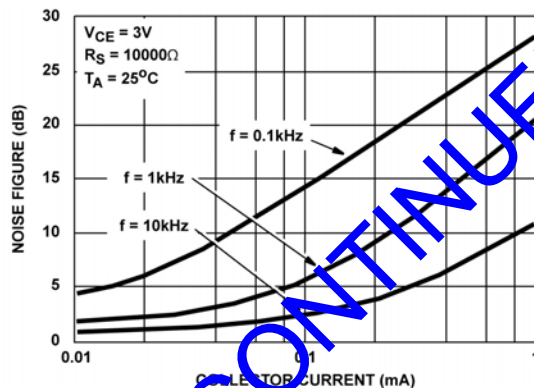

FIGURE 10. Typical Noise Figure vs Collector Current

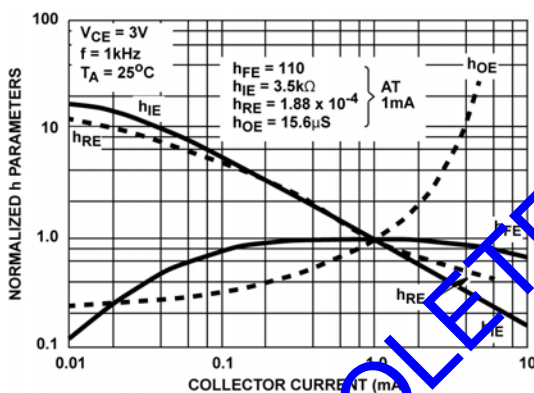

FIGURE 11. Typical Normalized Forward Current Transfer Ratio, Short Circuit Input Impedance, Open Circuit Output Impedance, And Open Circuit Reverse Voltage Transfer Ratio vs Collector Current

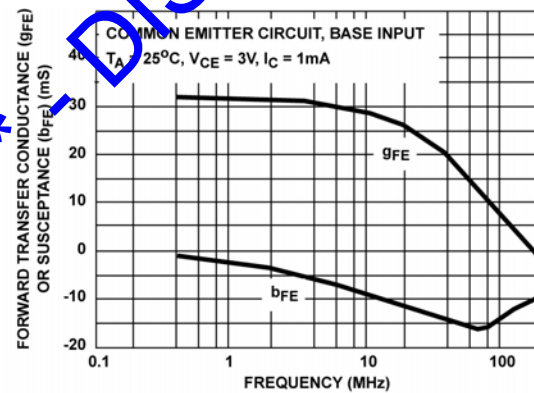

FIGURE 12. Typical Forward Transfer Admittance vs Frequency

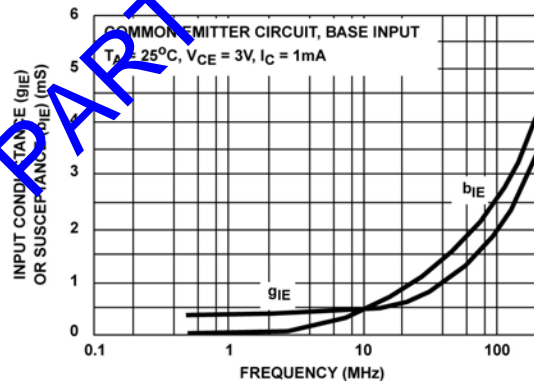

FIGURE 13. Typical Input Admittance vs Frequency

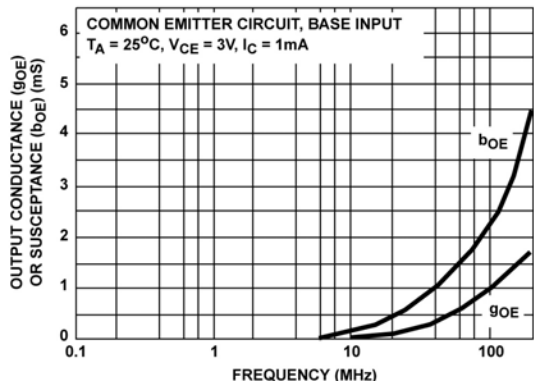

FIGURE 14. Typical Output Admittance vs Frequency





Monolithic Transistor Array – SiS3046

Rev 1.1
20/10/17

Typical Performance Characteristics (Continued)

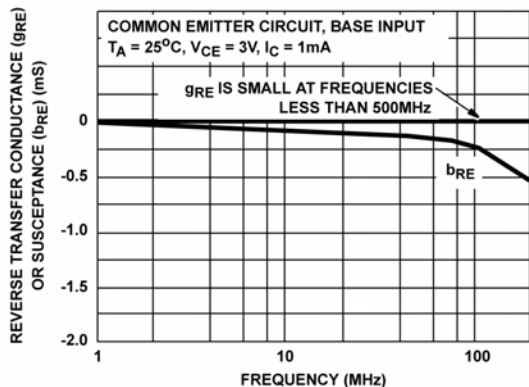

FIGURE 15. Typical Reverse Transfer Admittance vs Frequency

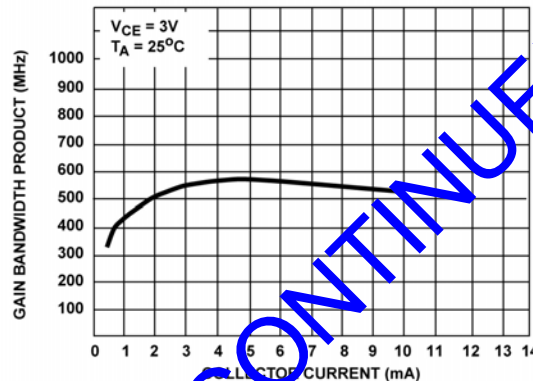

FIGURE 16. Typical Gain Bandwidth Product vs Collector Current

DISCLAIMER: The information given in this document shall in no event be regarded as a guarantee of conditions or characteristics. With respect to any examples or hints given herein, any typical values stated herein and/or any information regarding the application of the device, Silicon Supplies Ltd hereby disclaims any and all warranties and liabilities of any kind.

LIFE SUPPORT POLICY: Silicon Supplies Ltd components may be used in life support devices or systems only with the express written approval of Silicon Supplies Ltd, if a failure of such components can reasonably be expected to cause the failure of that life support device or system or to affect the safety or effectiveness of that device or system. Life support devices or systems are intended to be implanted in the human body or to support and/or maintain and sustain and/or protect human life. If they fail, it is reasonable to assume that the health of the user or other persons may be endangered.

