



Linear Voltage Regulator – LM117

Positive Adjustable 1.5A output Voltage Regulator in bare die form

Rev 1.0
03/03/18

Description

The LM117 is a high voltage adjustable 3-terminal voltage regulator with guaranteed 1.5A output current and equipped with internal limiting + thermal shutdown features for overload immunity. Output voltage is set by two external resistors. Additional to standard regulator function, the device can be used as a simple adjustable switching regulator; a programmable output regulator; or by connecting a fixed resistor between adjustment pin and output, can be used as a precision current regulator. A shutdown mechanism can be introduced by clamping the adjust terminal to ground which programs output to 1.2V where most loads draw little current.

Features:

- Full Military Temperature Range
- Output current in excess of 1.5A
- Adjustable output between 1.2V - 37V
- Internal short circuit current limit
- Internal thermal overload protection
- Output transistor Safe-Area Compensation
- Floating operation for high voltage applications
- 0.01% Line, 0.3% Load regulation maximum
- Negative Voltage complement is [LM137](#)

Ordering Information

The following part suffixes apply:

- No suffix - MIL-STD-883 /2010B Visual Inspection
- "H" - MIL-STD-883 /2010B Visual Inspection + MIL-PRF-38534 Class H LAT
- "K" - MIL-STD-883 /2010A Visual Inspection (Space) + MIL-PRF-38534 Class K LAT

LAT = Lot Acceptance Test.

For further information on LAT process flows see below.

www.siliconsupplies.com/quality/bare-die-lot-qualification

Die Dimensions in μm (mils)

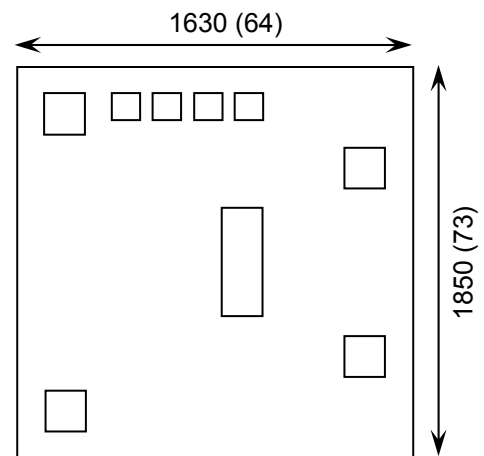

Supply Formats:

- Default – Die in Waffle Pack (100 per tray capacity)
- Sawn Wafer on Tape – On request
- Unsawn Wafer – On request
- Tape & Reel – On request
- In Metal or Ceramic package – On request

Mechanical Specification

Die Size (Unsawn)	1630 x 1850 64 x 73	μm mils
Minimum Bond Pad Size	140 x 140 5.51 x 5.51	μm mils
Die Thickness	350 (± 20) 13.78 (± 0.79)	μm mils
Top Metal Composition	Al 1%Si 2.2 μm	
Back Metal Composition	Ti/Ni/Ag 1.2 μm	





Linear Voltage Regulator – LM117

Rev 1.0
03/03/18

Pad Layout and Functions

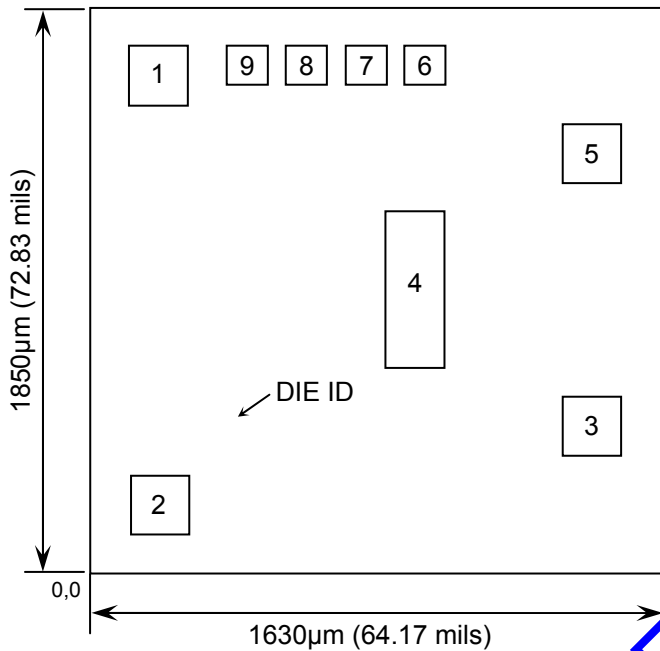

PAD	FUNCTION	COORDINATES (mm)	
		X	Y
1	V _{OUT}	0.073	1.637
2	ADJ	0.073	0.073
3	V _{OUT}	1.400	0.331
4	V _{IN} (X2 wires)	0.773	0.714
5	V _{OUT}	1.400	1.402
6	NC	0.641	1.715
7	NC	0.512	1.715
8	NC	0.383	1.715
9	NC	0.254	1.715

NC = NO CONNECT
CONNECT CHIP BACK TO V_{OUT}

Typical Application

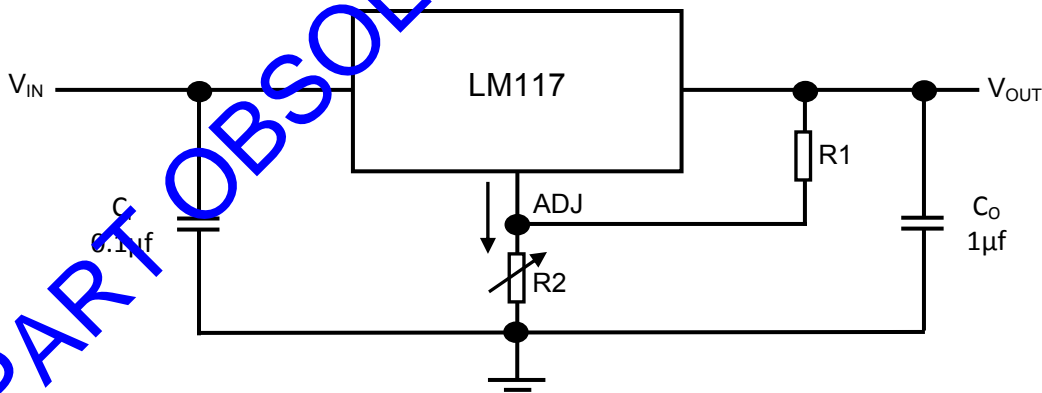

1.2V–25V Adjustable Regulator

$$V_{OUT} = 1.25V \left(1 + \frac{R_2}{R_1}\right) + I_{ADJ} * R_2$$

I_{ADJ} tolerance <100µA

C₁ is required if the regulator is located an appreciable distance from power supply filter. C₀ is not required for stability; however it does improve transient response. For optimum stability and transient response locate C₁ C₀ as close as possible to the regulator.





Linear Voltage Regulator – LM117

Rev 1.0
03/03/18

Absolute Maximum Ratings¹

PARAMETER	SYMBOL	VALUE	UNIT
Input–Output Voltage differential	$V_{IN} - V_{OUT}$	40	V
Power Dissipation	P_D	Internally Limited	
Operating Junction Temperature	T_J	150	°C
Storage Temperature	T_{STG}	-65 to 150	°C

Recommended Operating Conditions

PARAMETER	SYMBOL	MIN	MAX	UNIT
Output Voltage	V_{OUT}	1.25	37	V
Input–Output Voltage differential	$V_{IN} - V_{OUT}$	4	40	V
Output Current	I_{OUT}	0.01	1.5	A
Operating Junction Temperature Range	T_J	-55 to 125		°C

DC Electrical Characteristics, $V_{IN} - V_{OUT} = 5V$, $I_{OUT} = 0.5A$, $I_{MAX} = 1.5A$, $T_J = -55^\circ C$ to $+125^\circ C$ (unless noted otherwise)

PARAMETER	SYMBOL	TEST CONDITIONS	MIN	TYP	MAX	UNITS
Reference Voltage	V_{REF}	$3V \leq V_{IN} - V_{OUT} \leq 40V$, $10mA \leq I_{OUT} \leq I_{MAX}$	1.20	1.25	1.30	V
Line Regulation ²	ΔV_{OUT}	$3V \leq V_{IN} - V_{OUT} \leq 40V$, $T_J = 25^\circ C$	-	0.01	0.02	% / V_{OUT}
		$3V \leq V_{IN} - V_{OUT} \leq 40V$	-	0.02	0.05	
Load Regulation ²	ΔV_{OUT}	$V_{IN} \leq 5V$, $10mA \leq I_{OUT} \leq I_{MAX}$, $T_J = 25^\circ C$	-	5	25	mV
		$V_{IN} \geq 3V$, $10mA \leq I_{OUT} \leq I_{MAX}$, $T_J = 25^\circ C$	-	0.1	0.3	% / V_{OUT}
		$V_{IN} \leq 5V$, $10mA \leq I_{OUT} \leq I_{MAX}$	-	20	70	mV
		$V_{IN} \geq 5V$, $10mA \leq I_{OUT} \leq I_{MAX}$	-	0.3	1	% / V_{OUT}
Thermal Regulation		20ms pulse, $T_J = 25^\circ C$	-	0.03	0.07	% / W
Adjustment Pin Current	I_{ADJ}		-	50	100	μA
Adjustment Pin Current Change	ΔI_{ADJ}	$2.5V \leq V_{IN} - V_{OUT} \leq 40V$, $10mA \leq I_L \leq I_{MAX}$, $P_D \leq P_{MAX}$	-	0.2	5	μA
Temperature Stability	-	$T_{LOW} \leq T_J \leq T_{HIGH}$	-	1	-	%
Minimum Load Current	I_L	$ V_{IN} - V_{OUT} = 40V$	-	3.5	5	mA
Output Current Limit ³	I_{MAX}	$ V_{IN} - V_{OUT} \leq 15V$, $P \leq 20W$	1.5	2.2	-	A
		$ V_{IN} - V_{OUT} = 40V$, $P \leq 20W$, $T_J = 25^\circ C$	0.3	0.40	-	

1. Operation above the absolute maximum rating may cause device failure. Operation at the absolute maximum ratings, for extended periods, may reduce device reliability.

2. Regulation is measured at a constant junction temperature, using pulse testing with a low duty cycle. Changes in output voltage due to heating effects are covered under the specifications for thermal regulation.





Linear Voltage Regulator – LM117

Rev 1.0

03/03/18

DC Electrical Characteristics, $V_{IN}-V_{OUT}=5V$, $I_{OUT}=0.5A$, $I_{MAX}=1.5A$, $T_J = -55^{\circ}C$ to $+125^{\circ}C$ (unless noted otherwise)

PARAMETER	SYMBOL	TEST CONDITIONS	MIN	TYP	MAX	UNITS
RMS Output Noise, % of V_{OUT}	eN	$10\text{ Hz} \leq f \leq 10\text{ kHz}$, $T_J = 25^{\circ}C$	-	0.003	-	%
Ripple Rejection Ratio	RR	$V_{OUT} = 10V$, $f = 120\text{ Hz}$, $C_{ADJ} = 0\mu F$	-	65	-	dB
		$V_{OUT} = 10V$, $f = 120\text{ Hz}$, $C_{ADJ} = 10\mu F$	66	80	-	
Long Term Stability	-	$T_A = 125^{\circ}C$, 1000 hrs	-	0.3	1	%
Thermal Resistance ³	$R\theta_{JC}$	$T_{LOW} \leq T_J \leq T_{HIGH}$	-	2	-	$^{\circ}C/W$

3. Assembled in TO-3 package. Die performance is dependent on die attach, substrate choice & assembly method.

Typical Electrical Characteristics, $T_J = 25^{\circ}C$ (unless noted otherwise)

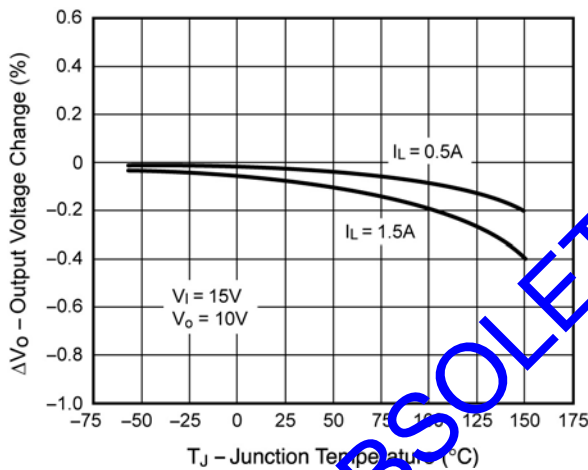

Figure 1 – Load Regulation

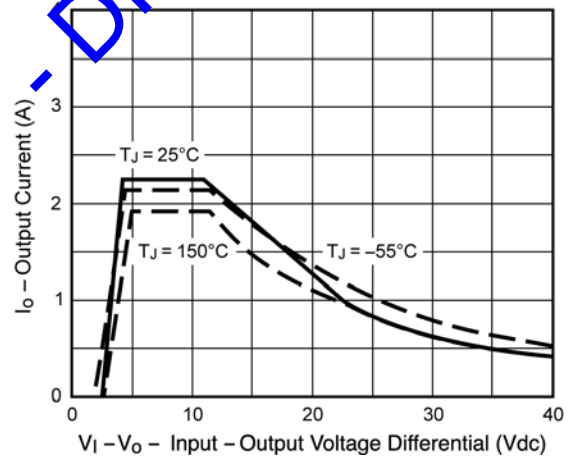

Figure 2 – Current Limit

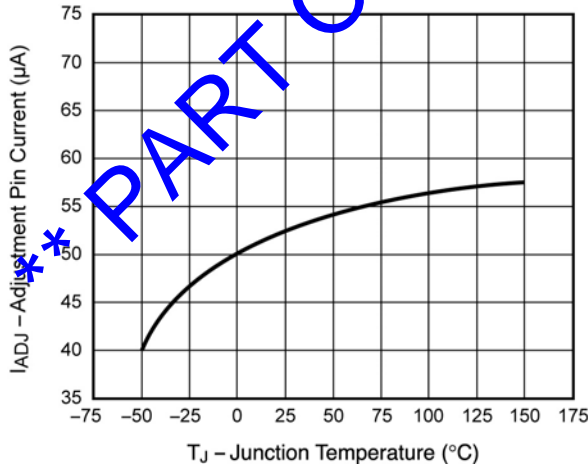

Figure 3 – Adjustment Pin Current

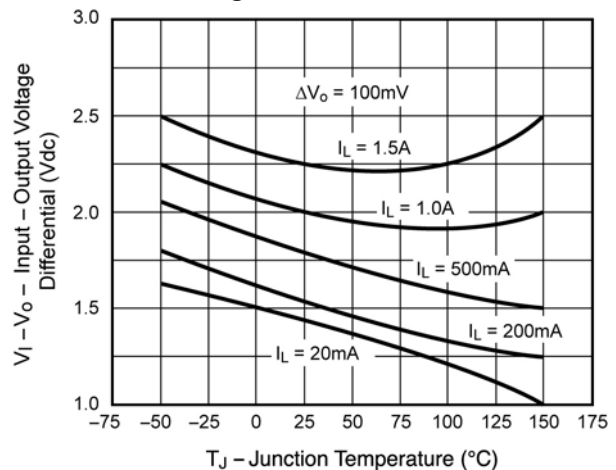

Figure 4 – Dropout Voltage





Linear Voltage Regulator – LM117

Rev 1.0

03/03/18

Typical Electrical Characteristics, $T_J = 25^\circ\text{C}$ (unless noted otherwise)

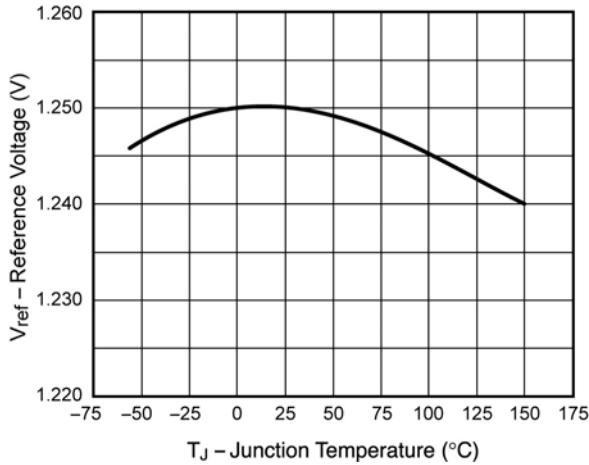

Figure 5 – Temperature Stability

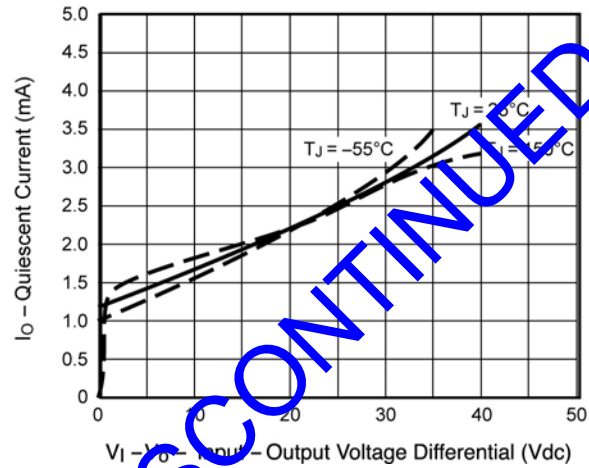

Figure 6 – Minimum Operating Current

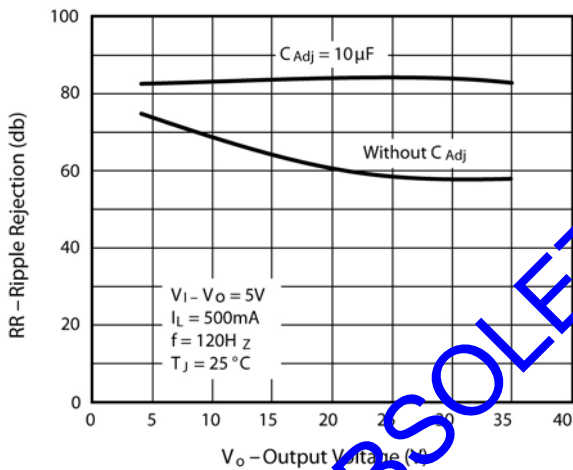

Figure 7 – Ripple Rejection versus Output Voltage

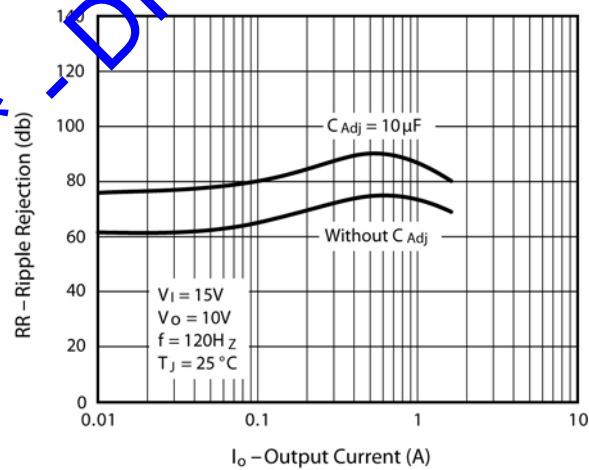

Figure 8 – Ripple Rejection versus Output Current

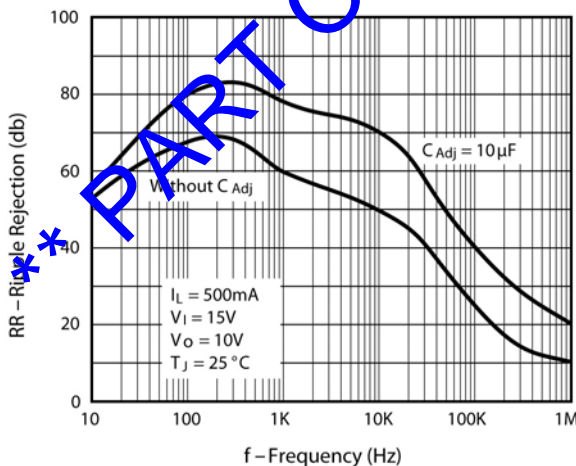

Figure 9 – Ripple Rejection versus Frequency

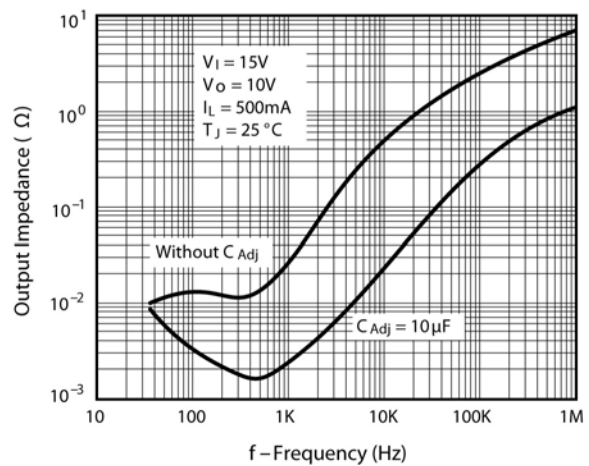

Figure 10 – Output Impedance





Linear Voltage Regulator – LM117

Rev 1.0

03/03/18

Typical Electrical Characteristics, $T_J = 25^\circ\text{C}$ (unless noted otherwise)

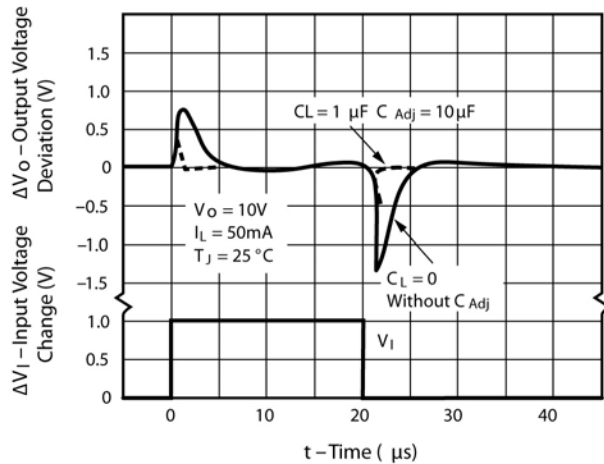

Figure 11– Line Transient Response

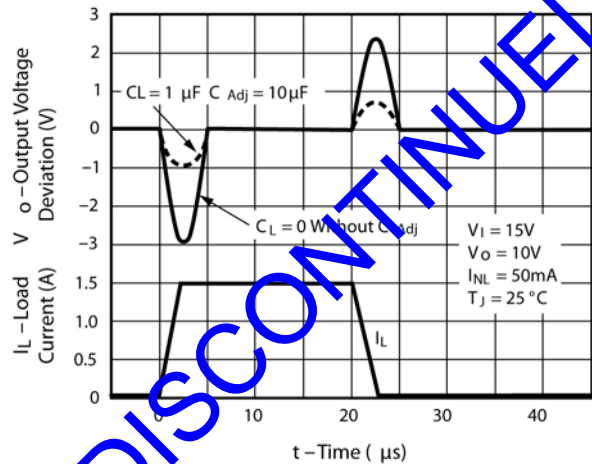

Figure 12– Load Transient Response

DISCLAIMER: The information given in this document shall in no event be regarded as a guarantee of conditions or characteristics. With respect to any examples or hints given herein, any typical values stated herein and/or any information regarding the application of the device, Silicon Supplies Ltd hereby disclaims any and all warranties and liabilities of any kind.

LIFE SUPPORT POLICY: Silicon Supplies Ltd components may be used in life support devices or systems only with the express written approval of Silicon Supplies Ltd, if a failure of such components can reasonably be expected to cause the failure of that life support device or system or to affect the safety or effectiveness of that device or system. Life support devices or systems are intended to be implanted in the human body or to support and/or maintain and sustain and/or protect human life. If they fail, it is reasonable to assume that the health of the user or other persons may be endangered.

